



YBLT-3, YBLT-4 Foot Switch

1. General

The foot switch YBLT-3,4 series is suitable for alternating current 50Hz/60Hz;and the control lines of voltage to 380V,volts d.c.to 220V;as control machine tools electric,medical facility.

In accordance with standard: GB/T 14048.5, IEC 60947-5-1.

2. Type designation

YB LT - □
 |
 | Design sequence No.
 |
 | Foot switch
 |
 | Type of improved product

Contact type

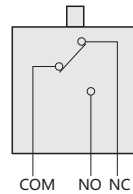

3. Overall and mounting dimensions

Voltage current:AC-15 380V ; DC-13 220V;

Voltage current:AC-15 0.79A ; DC-13 0.14A;

Promise heating current:3A;

Sheathing material:YBLT-3, YBLT-4 cast aluminum alloy;

Level of protection:IP31;

Installation category:II;

Pollution degree:class3;

Insulation voltage U_i :415V;

Rated impulse withstand voltage U_{imp} :4KV.

YBLT-3

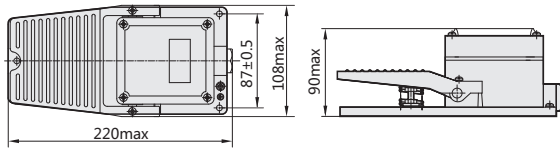

YBLT-4

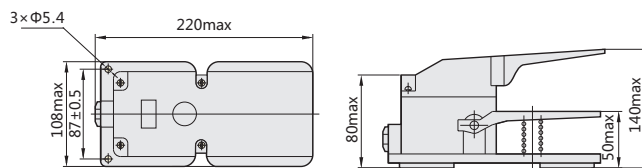

YBLT-4



4. Ordering information

The full model number, name and quantity of the switch should be given when ordering.
For example: YBLT-3 foot switch, 100 pieces

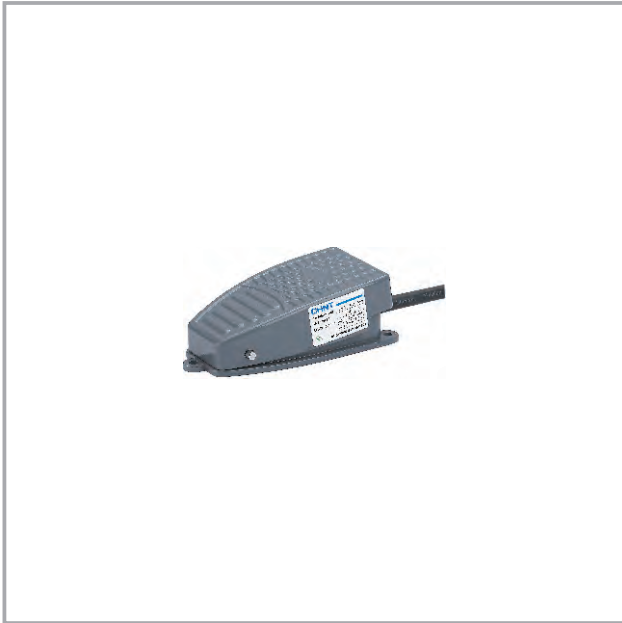

YBLT-EKW/5A/B Foot Switch

1. General

The foot switch YBLT-EKW/5A/B series is suitable for alternating current 50~60Hz; and the control lines of voltage to 380V, volts d.c. to 220V; as control machine tools electric, medical facility etc.

In accordance with standard: GB/T 14048.5, IEC 60947-5-1.

2. Type designation

YB LT - EKW/5A /B
 Type B
 Promise heating current
 Design sequence No.
 Foot switch
 Type of improved product

Contact type

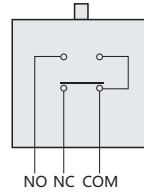

3. Overall and mounting dimensions

Voltage rating: AC-15 380V ; DC-13 220V;
 Voltage current: AC-15 0.8A ; DC-13 0.16A;
 Promise heating current: 5A;
 Switch element: YBLX-19/K Sheathing;
 material: cast aluminum alloy;
 Level of protection: IP20;
 Installation category: II;
 Pollution degree: class3;
 Insulation voltage U_i : 500V;
 Rated impulse withstand voltage U_{imp} : 2.5KV;
 Operation frequency: 20t/min;
 Ambient temperature: -5°C - +40°C.

YBLT-EKW/5A/B

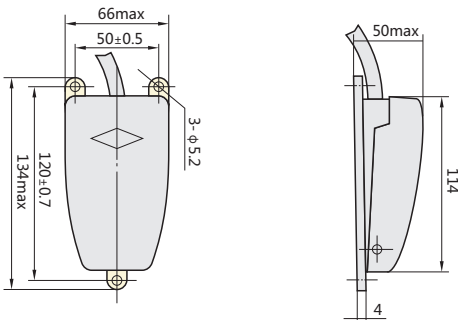

4. Ordering information

The full model number, name and quality of the switch should be given when ordering.
 For example: YBLT-EKW/5A/B foot switch, 100 piece



YBLT-FS/1 Foot Switch

1. General

Voltage rating:AC-15 380V ; DC-13 220V;
Voltage current:AC-15 0.79A ; DC-13 0.14A;
Promise heating current:5A;
Sheathing material:YBLT-FS/1 armor plate.

2. Overall and mounting dimensions

YBLT-FS/1

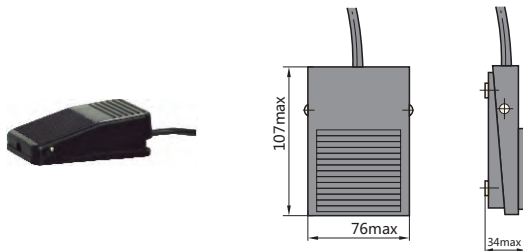

Contact type

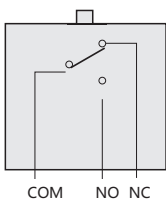

3. Ordering information

The full model number,name and quality of the switch should be given when ordering.
For example: YBLT-FS/1 foot switch, 100 peace



YBLT-FS/201 Foot Switch

1. General

YBLT-FS/201 foot switches apply to the control circuit, whose alternating current is 50Hz/60Hz, voltage is 380V, direct current is 220V, as electrical control of machinery tools, armarium and so on. The normal operation of switch is on altitude, which is not exceeding 2000m, ambient temperature is -30°C~+40°C, relative air humidity is not more than 85%; up to standard: GB/T 14048.5, IEC 60947-5-1.

2. Type designation

YB LT- FS/□

Design sequence No.

Foot switch

Improved product

Contact type

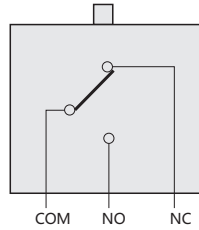

3. Overall and mounting dimensions

Rated current: AC-15 380V ; DC-13 220V;
 rated current: AC-15 0.8A ; DC-13 0.16A;
 agreed heating current: 5A;
 canning material: plastic.

YBLT-FS/201

