



NVF5 Series
Inverters

User Instruction

Preface

Thank you for choosing CHINT NVF5 series inverter.

Featuring fast load response, large low frequency torque and high overload capacity, the NVF5 series inverter adopts speed sensorless vector control technology to achieve precise control of various equipment. With its constant voltage output, torque limitation, rotational speed tracking, simplified PLC and process PID functions, this product is designed to meet the electrical driving demands of various applications including wiredrawing, textile, machine tool, papermaking, packaging, food, plastic, fans and pumps, and all kinds of automatic production equipment.

NVF5 series inverter is equipped with multiple communication functions such as standard RS485 communication protocol, scalable Ethernet, Profibus-DP, Devicenet and CANopen. It is also equipped with multiple scalable I/O ports to meet the demands for complex onsite operation and system integration.

Fully taking into account the harmonic interference from power grid as well as the dust and oil pollutions that may occur to the product, the NVF5 series inverter is equipped with internal anti-harmonic interference circuit which can suppress harmonic interference efficiently. Its modular structure can prevent dust and oil from entering inside the machine. For NVF5-7.5/TS4-B series and below, user can add an optional dust guard to achieve IP22 protection so the product can be used under various complex conditions.

NVF5 series inverter offers three menu modes (Simple, Customized and Engineering) to meet the needs of different users. The Simple mode offers simple operations which are easy to learn and use, this mode is applicable to beginners. The Customized mode offers customizable menu options which are applicable to dedicated equipment commissioning personnel. The Engineering mode includes all functional parameters which is applicable to professional inverter commissioning personnel.

This manual introduces the functions and operations of NVF5 series inverter, including product selection, installation and commissioning, and various parameters. Before using the inverter, please read this manual carefully to ensure correct operations. After reading this manual, please keep it properly for later use.

If you run into any difficulties or problems that you cannot handle during operation, please contact our local dealer or our professional technicians for help. (400 hotline: 400-8177-777)

We reserve the right to continuously optimizing and improving the NVF5 series inverter. The information in this manual is subject to change without prior notice.

Safety Warning

- 1 Check the product nameplate with your order, do not install the product if there is any inconsistency;
- 2 Do not install and operate the product if there is any damage in appearance or missing of any parts, otherwise it may cause fire or injury;
- 3 To avoid dangerous accidents, the product must be installed and wired strictly according to the instructions;
- 4 Do not install the product in inflammable, explosive, humid and condensing environment;
- 5 Do not install the product in places where there is direct sunshine or water leakage, otherwise the equipment can be damaged;
- 6 Do not use your hands to touch main circuit terminals, control circuit terminals, electric components and internal parts of the inverter directly;
- 7 The inverter must be installed by qualified person, otherwise electric shock can occur;
- 8 The inverter must be isolated from power supply through circuit breaker, otherwise there will be a risk of fire;
- 9 The power and load connected to the inverter should comply with the requirements for inverter input power and its matching motor;
- 10 When installing external live conductor, the exposed parts of the conductor should be insulated to avoid electric shock;
- 11 Before installing, maintaining and servicing the inverter, turn off the power and wait for 10 minutes;
- 12 The inverter has gone through dielectric withstand voltage test before delivery. It is prohibited to conduct such test on the inverter again, otherwise the equipment can be damaged;
- 13 If the length of motor cable exceeds 100 meters, user should use stranded wire and install an AC output reactor to suppress high frequency oscillation, so as to prevent motor insulation damage or too much leak current;
- 14 Non-professional is prohibited to conduct signal testing during operation, otherwise personal injury or equipment damage may occur;
- 15 Do not start and stop the inverter frequently by connecting and disconnecting the power supply, otherwise the equipment damage may occur;
- 16 In civil applications, the product may cause radio interference. In such cases, user may have to take control measures such as installing reactor or filter;
- 17 The electrolytic capacitors in the main circuit and those on the printed board may explode and the plastic components (such as panel) may generate poisonous gas during the disposal process, therefore they should be disposed of as industrial waste;
- 18 It is prohibited to conduct maintenance, service and inspection on live products, otherwise electric shock may occur.

Catalog

1	Main Usage Scope of Application	01
	1.1 Main Usage and Scope of Application	01
	1.2 Precautions	01
2	Type Key Explanation	03
3	Conditions for Normal Use, Installation and Transportation and Storage	04
	3.1 Conditions for Use, Transportation and Storage	04
	3.2 Installation Conditions	04
4	Key Technical Parameters and Performance	05
5	Structure and Operating Principles	06
	5.1 Product Structure	06
	5.2 Operating Principle Diagram	06
	5.3 Wiring Symbols of Main Circuit Terminals	07
	5.4 Use Instruction of Multifunction Input/Output Terminals	09
6	Outline and Installation Dimensions and Weight	11
	6.1 Product Outline and Installation Dimensions and Weight	11
	6.2 External Panel and Cabinet Door Perforating Dimensions	12
7	Installation, Commissioning and Operation	13
	7.1 Installation	13
	7.2 Wiring	15
	7.3 Use Instructions of Operation Panel	18
	7.4 Menu Operation Mode	20

7.5 Keyboard Lockout and Password Setup	23
7.6 Simple Mode Menu and Basic Commissioning Process	23
8 Notes for Maintenance, Care and Storage	27
8.1 Daily Maintenance and Care	27
8.2 Maintenance and Care during Operation	27
8.3 Inspection and Repair Cycle	27
8.4 Maintenance and Care for Long Term Idle	28
8.5 Regular Inspection	28
8.6 Replacement of Wearing Parts	28
9 Fault Analysis and Troubleshooting	29
9.1 Fault Analysis	29
9.2 Troubleshooting	29
10 Environmental Protection	34
11 Product Model Selection and Order Information	35
12 Appendix	36
12.1 Parameter Summary Table	36

1 Main Usage Scope of Application

1.1 Main Usage and Scope of Application

Featuring fast load response, large low frequency torque and high overload capacity, the NVF5 series inverter adopts speed sensorless vector control technology to achieve precise control of various equipment. With its constant voltage output, torque limitation, rotational speed tracking, simplified PLC and process PID functions, this product is designed to meet the electrical driving demands of various applications including wiredrawing, textile, machine tool, papermaking, packaging, food, plastic, fans and pumps, and all kinds of automatic production equipment.

1.2 Precautions

Table 1.1 Precautions

Precautions	Explanations
Comparison with frequency type operation	This is a voltage type inverter with output voltage of PWM wave which includes a certain proportion of harmonic. Therefore, temperature rise, noise and vibration during operation might be slightly bigger than those in frequency type operation.
Constant torque low speed operation	When the inverter is used to drive the long-term low-speed operation of regular motors, the output torque limit should be decreased due to the poor heat dissipation of the motor. If you need to use the inverter for long-term low-speed operation with constant torque, you must choose a variable frequency motor.
Electronic thermal protection value of motor	If a matching motor is selected, the inverter can provide thermal protection for the motor. If the rated capacity of the selected motor does not match with that of the inverter, make sure to set up a proper protection value or take other protective measures to guarantee the safe operation of the motor.
Operate above 50Hz	If you need to run the product above 50Hz, please pay attention to the increase in motor vibration and noise; remember to check the speed range of motor bearings and mechanical devices first.
Lubrication of mechanical devices	The lubrication effect of mechanical devices such as reduction gearbox and gear will reduce over long-term low-speed operation, which may lead to equipment damage; please check the lubrication in advance.
Negative torque load	Negative torque often occurs in applications where load increase is needed, which makes inverter to trip due to overcurrent or overvoltage. In such case, user should use braking components with proper parameters.
Mechanical resonance point of load bearing device	The input frequency range of the inverter may include the mechanical resonance point of load bearing device. In such case, user must set up a hopping frequency to bypass the mechanical resonance point.
Frequent start and stop	Use terminals to control the start and stop of inverter. It is prohibited to use switching devices such as contactor for frequent start and stop operations at the input side of the inverter, otherwise the equipment can be damaged.
Motor insulation check before connecting the inverter	<p>Before using the motor for the first time or after long-term idle, check the insulation of the motor so that the inverter will not be damaged due to invalid insulation of motor winding. See the figure for wiring. Use 500V voltage type megameter for measurement. The insulation resistance should not be smaller than 5MΩ.</p> 

Table 1.1 (Continued)

Precautions	Explanations
Capacitors or pressure sensitive components with improved power factor	Since the inverter outputs PWM wave, if any capacitors or pressure sensitive components for lightning protection with improved power factor are installed at input side, they may cause inverter to trip or lead to component damage. Please remove these devices.
Use of switching devices such as inverter output terminal installation contactor	If user needs to install switching devices such as contactor between inverter output and motor, please make sure the inverter can make and break smoothly when there is no output, otherwise the inverter can be damaged
Applications beyond rated voltage	The inverter is not suitable for applications beyond permissible operating voltage. If needed, please use corresponding voltage increase or decrease devices for voltage transformation.

The model on product nameplate uses combination of numbers and letters to indicate the series of the product, as shown in Figure 2-1.

2 Type Key Explanation

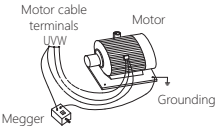
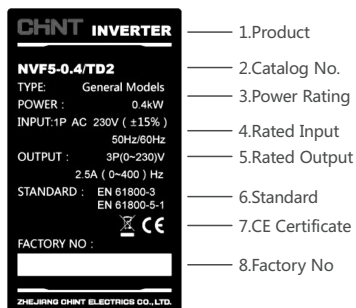

Figure 2-1 Nameplate of NVF5 series inverter

Note: NVF5 series inverter has CE mark which means the product is CE certified and complies with European Low Voltage Directive (LVD) and EMC Directive.

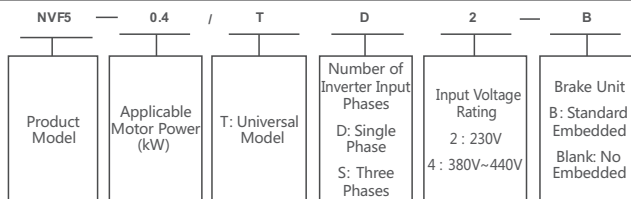

Figure 2-3 NVF5 series inverter type key definitions

2.1 Product Specifications

Table 2.1 Inverter specifications table

Power voltage	Inverter model	Power capacity kVA	Rated input current A	Rated output current A	Max. motor power kW	Braking unit
Single phase AC 230V	NVF5-0.4/TD2	1.0	5.4	2.5	0.4	None
	NVF5-0.75/TD2	1.9	10.3	5	0.75	
	NVF5-1.5/TD2	2.9	15.5	7.5	1.5	
	NVF5-2.2/TD2	4.2	20	10	2.2	
	NVF5-0.4/TD2-B	1.0	5.4	2.5	0.4	Built-in as standard
	NVF5-0.75/TD2-B	1.9	10.3	5	0.75	
	NVF5-1.5/TD2-B	2.9	15.5	7.5	1.5	
3-phase AC 380V~440V	NVF5-2.2/TD2-B	4.2	20	10	2.2	Built-in as standard
	NVF5-0.4/TS4-B	0.8	2.3	1.5	0.4	
	NVF5-0.75/TS4-B	1.5	3.4	2.7	0.75	
	NVF5-1.5/TS4-B	3.0	5.1	4.2	1.5	
	NVF5-2.2/TS4-B	4.0	6.6	5.8	2.2	
	NVF5-3.7/TS4-B	5.9	12.1	10.5	3.7	
	NVF5-5.5/TS4-B	8.6	13.1	13	5.5	
NVF5-7.5/TS4-B	11.0	22.2	17	7.5		

3 Conditions for Normal Use, Installation and Transportation and Storage

3.1 Conditions for Use, Transportation and Storage

- Ambient temperature for storage: $-40^{\circ}\text{C} \sim +70^{\circ}\text{C}$;
- Ambient temperature for operation: $(-10 \sim +45)^{\circ}\text{C}$, derate between $45^{\circ}\text{C} \sim 50^{\circ}\text{C}$ (derate 1% with every 1°C temperature rise);
- Relative humidity $(5 \sim 95)\% \text{RH}$;
- For applications above 1000m altitude, derate 1% for every 100m altitude rise, but do not use it above 3,000m altitude;
- $(2 \sim 9)\text{Hz}$ amplitude $\leq 0.3\text{mm}$, $(9 \sim 200)\text{Hz}$ vibration acceleration $\leq 5.8\text{m/s}^2$;

Note: For long-term idled inverters, user must power it on at least once every 2 years. Use voltage regulator to raise the voltage to rated value slowly, and run the inverter for 1 hour without load, otherwise electric shock or explosion may occur.

3.2 Installation Conditions

- The inverter should be installed indoor, with good ventilation. Usually, we recommend vertical installation.
- The inverter should be installed indoor and protected from direct sunshine, dust, corrosive gas, inflammable gas, oil spray, steam, water drop and salt;
- Pay attention to the installation interval and distance when using the inverter. See Figure 3-1 and 3-2 for parallel and vertical installation of multiple inverters respectively.

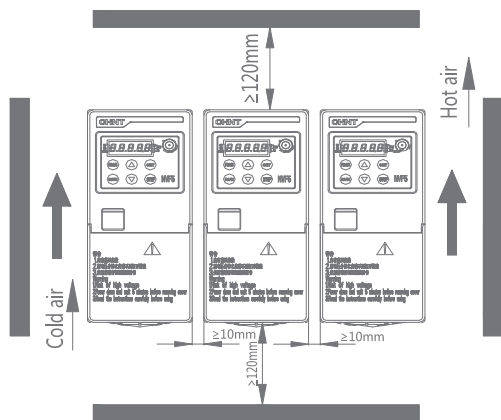

Figure 3-1 Inverter installation diagram

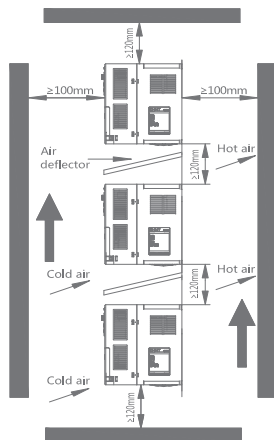

Figure 3-2 Vertical installation of multiple inverters

4 Key Technical Parameters and Performance

Table 4.1 Universal technical parameters and performance

Item		Description
Input	Voltage range	3 phase: 380~440V : 380 V(-15%)~440 V(+15%) single phase: 230V : 230 V(±15%)
	Frequency range	(47~63)Hz
Output	Voltage	0~rated input voltage
	Frequency	(0~400)Hz
Main control performance	Overload capacity	Universal: 150% rated current for 1 minute, 180% rated current for 2 seconds
	Control mode	SVC control, V/F control
	Starting torque	SVC control: 150% rated torque at 0.5Hz V/F control: 100% rated torque at 1Hz
	Switching frequency	1kHz~15kHz
	Speed regulation ratio	SVC: 1:100; V/F: 1: 50
	Speed control precision	±0.5% max. speed
	Frequency resolution	Digital reference setting: 0.01Hz; Analog setting: max. frequency ×0.5%
	V/F curve	Linear V/F curve; (2, 1.7, 1.2, multiple points) descending powers torque curve
Acceleration and deceleration curve	4 types of linear acceleration and deceleration; S curve acceleration and deceleration	
Features		Overcurrent stalling protection, overvoltage stalling protection, torque limit, rotating speed tracking, simplified PLC, process PID, multi-segment speed control, automatic slip compensation, automatic torque raise, pre-excitation, instantaneous power failure/non-stop.
Peripheral interfaces	Digital input	5 way multifunction programmable digital input (include 1 way high speed impulse input terminal)
	Digital output	1 way multifunction programmable digital input (speed up to 100kHz)
	Analog input	2 way analog signal input, (0 ~ 20)mA, (4 ~ 20)mA current signal input or (0 ~ 10)V, (-10 ~ +10)V voltage signal input available
	Analog output	1 way analog signal output, (0 ~ 20)mA, (4 ~ 20)mA current signal output or (0 ~ 10)V voltage signal output available
	Relay output	Universal: a pari of NO contacts and a pair of NC contacts: capacity: 3A/250V Water supply: 2 way relay output, 1 way NO/NC, 1 way NO. Contact capacity: NO 5A /NC 3A 250V(AC)
	Communicatio interface	Standard RS485 communication, multiple scalable communication protocols, connected to external remote operation panel;
	Braking function	Built-in braking unit is optional for single phase model and standard for 3-phase model
	Operation panel	Displays more than 20 paramenters including set frequency, output frequency, output voltage and output current.
Protective functions		Provides overcurrent protection, overvoltage protection ,undervoltage protection, overheat protection, overload protection, input phase loss protection, output phase loss protection, load drop protection, and motor earthing short circuit protection.
Protection class		IP20 for standard, up to IP22 after installing dust shield
Installation method		≤2.2kW uses rail mounting and wall mouning (wall mounting only for single phase 2.2kW); > 2.2kW uses wall mounting

5 Structure and Operating Principles

5.1 Product Structure

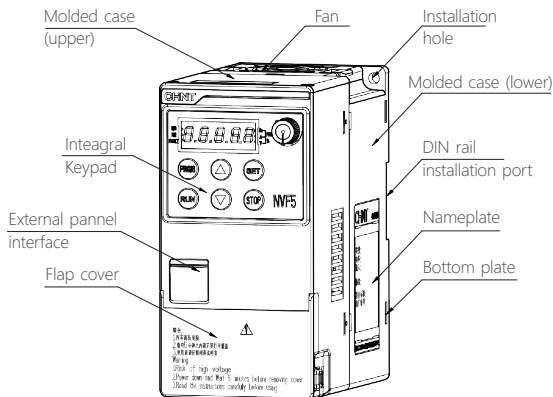

Figure 5-1 Outline drawing of NVF5-0.4/TD2~NVF5-2.2/TD2 and NVF5-0.4/TS4-B~NVF5-2.2/TS4-B, (the fan of NVF5-2.2/TD2 model is installed at the bottom of the inverter)

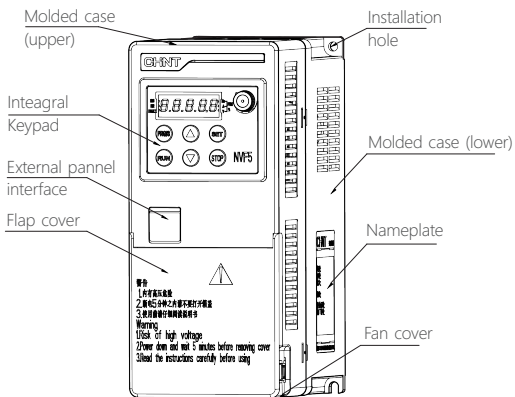

Figure 5-2 Outline drawing of NVF5-3.7/TS4-B~NVF5-7.5/TS4-B,

5.2 Operating Principle Diagram

AO DIP switch: (0~20)mA or (4~20)mA analog current output when switched to left; (0~10)V analog voltage output when switched to right.

AI1 DIP switch: (0~20)mA or (4~20)mA analog current input when switched to left; (-10 ~10)V analog voltage input when switched to right.

AI2: NVF5-0.4/TD2~NVF5-7.5/TS4 default voltage input, current type output needs to be customized.

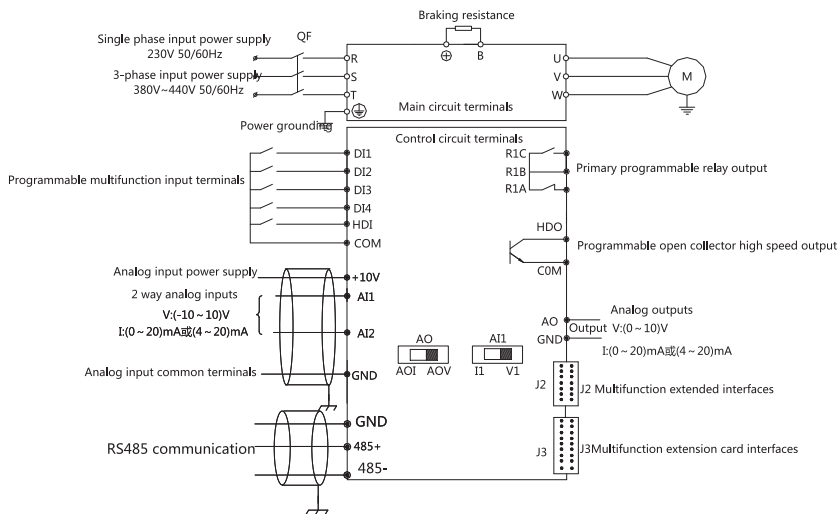

Figure 5-3 Wiring diagram of NVF5-0.4TD2~NVF5-7.5/TS4 terminals

AO DIP switch: (0~20)mA or (4~20)mA analog current output when switched to left; (0~10)V analog voltage output when switched to right.

AI1 DIP switch: (0~20)mA or (4~20)mA analog current input when switched to left; (-10 ~+10)V analog voltage input when switched to right.

5.3 Wiring Symbols of Main Circuit Terminals

The specification of screwdriver used for NVF5-0.4/TD2~ NVF5-2.2/TS4-B wiring should not exceed PH0, the specification of screwdriver used for NVF5-3.7/TS4-B~ NVF5-7.5/TS4-B wiring should not exceed PH1.

5.3.1 See figure 5-4 and Table 5.1 for single phase 230V series (NVF5-0.4/TD2~2.2/TD2)

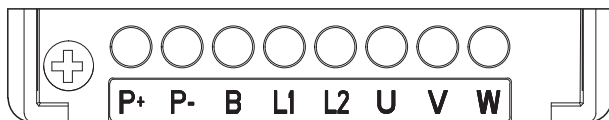

Figure 5-4 Main circuit terminals NVF5-0.4/TD2~2.2/TD2

5.3.2 See figure 5-5 and Table 5.1 for 3-phase 380V series (NVF5-0.4/TS4-B~7.5/TS4-B)

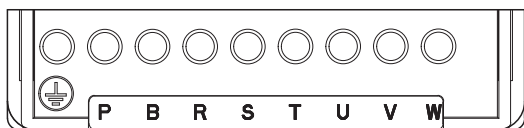



Figure 5-5 Main circuit terminals NVF5-0.4/TS4-B~7.5/TS4-B

Table 5.1 Functions of main circuit terminals

Terminal symbols	Terminal names	Function	Notes
R、S、T	Main circuit power input	3-phase AC voltage input terminal, connected to power grid	1. User must conduct wiring based on terminal functions, otherwise the inverter can be damaged or even cause fire; 2. The wire length of braking unit should not exceed 10m. Use twisted pair or close parallel pair for wiring; 3. When external braking resistance is used, do not connect the braking resistance directly to the DC bus, otherwise the inverter can be damaged or even cause fire.
L1、L2	Main circuit power input	Single phase AC voltage input terminal, connected to power grid	
U、V、W	Inverter output	3-phase AC voltage output terminal, usually connected to motor	
	Grounding terminal	Safety protection grounding terminal, must be grounded securely, with conductor sectional area not smaller than that of inverter input power line.	
P+ P-	Positive and negative terminals for DC bus	Positive and negative terminals for single phase DC bus	
P B	Connection terminal for external braking resistance	Connection terminal for braking resistance	
P+ B			

5.3.3 Wiring Symbols for Control Terminals

Choose conductor with sectional area of 1 mm² for control wire.

The strip length of control terminal should be (8~11)mm, as shown

in Figure 5-6. The core of the conductor should fully contact with the wiring terminal.

There should be no exposed core outside the terminal after the wiring is completed, otherwise it may cause short circuit

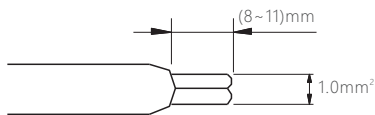
**Figure 5-6 Wire stripping requirements for control terminals**

5.3.4 Functions of Control Terminals

Table 5.2 Functions of control panel terminals

Category	Terminal	Name	Function	Specification
Analog input	AI1	Analog single terminal input AI1	AI1: choose voltage or current input by using DIP switch; the factory default settings of AI1 and AI2 are both voltage input.	Voltage signal input range: (-10 ~ +10)V Current signal input range: (0 ~ 20)mA or (4 ~ 20)mA
	AI2	Analog single terminal input AI2		
Analog output	AO	Analog output	Analog voltage/current signal output. Choose voltage or current signal by using DIP switch, see function code F6.08.	Voltage output range: (0 ~ 10)V Current output range: (0 ~ 20)mA or (4 ~ 20)mA

Table 5.2 (Continued)

Category	Terminal	Name	Function	Specification
Communication	485+	RS485 communication interface	Positive end of 485 differential signal	Standard RS485 communication interface Use twisted pair or shielded wire
	485-		Negative end of 485 differential signal	
Multifunction input terminals	DI1	Multifunction input terminal 1	Programmable multifunction switch input terminals, see function code F5.01~F5.05	Max. input frequency of DI1~DI4: 200Hz; the max. input frequency of HDI is 100kHz; the input voltage range is +(20~24)V , common terminal: COM.
	DI2	Multifunction input terminal 2		
	DI3	Multifunction input terminal 3		
	DI4	Multifunction input terminal 4		
	HDI	High speed input terminal HDI		
Multifunction output terminal	HDO	High speed pulse output terminal	Programmable multifunction pulse signal output terminal, see function code F6.09	Voltage range: +(20~24)V Current range: (0~50)mA Input frequency range: (0~100) kHz(set through F6.12)
Power	+24V	+24V power	Provide +24V power supply	Max. output current: 100mA
	COM	+24V power common terminal	Reference grounding of +24V power supply	COM and GND are internally isolated
Relay output terminal 1	R1A	Relay output 1	Programmable multifunction relay output terminal, see function code F6.02	R1A-R1B: NC; R1B-R1C: NO Capacity: NO 5A /NC 3A 250V(AC)
	R1B			
	R1C			
Relay output terminal 2	R2B	Relay output 2	Programmable multifunction relay output terminal, see function code F6.03	R2B-R2C: NO; Capacity: NO 5A 250V(AC)
	R2C			

5.4 Use Instruction of Multifunction Input/Output Terminals

5.4.1 Use Instruction of Multifunction Input Terminals

a) COM is the common terminal for DI1~DI4 and HDI. It is connected to +24V. The typical external connection method for DI1~DI4 and HDI is shown in Figure 5-7 and 5-8:

Dry contact method: use the internal +24V power of the inverter.

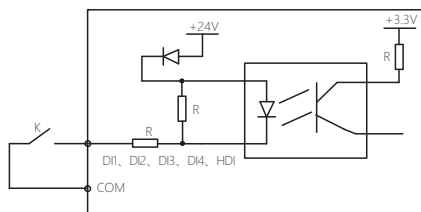
Figure 5-7 Connection method using internal +24V power

b) Drain electrode method: use the internal +24V power of the inverter, with NPN type external controller for common emitter output.

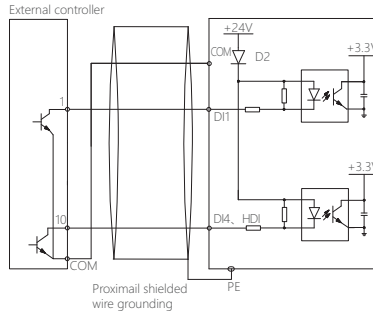

Figure 5-8 Source electrode connection method using the internal +24V power of the inverter

5.4.2 Use Instruction of Multifunction Output Terminals

a) HDO is used as digital pulse frequency output. It can use the internal +24V power of the inverter. See Figure 5-9 for wiring method

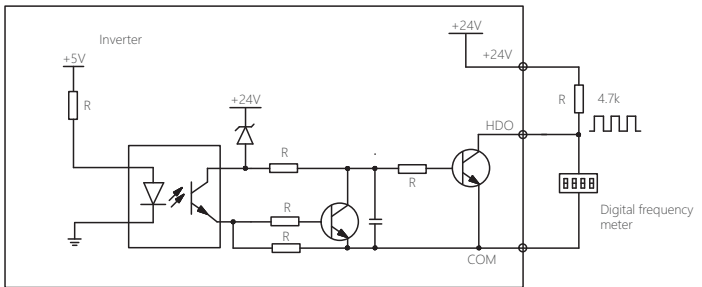

Figure 5-9 Wiring method 1 of output terminal HDO

b) HDO is used as digital pulse frequency output or external power supply. See Figure 5-10 for wiring method.

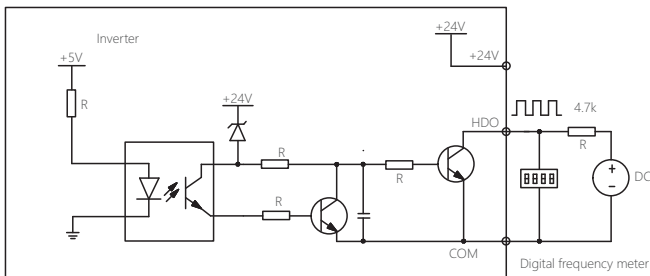

Figure 5-10 Wiring method 2 of output terminal HDO

6 Outline and Installation Dimensions and Weight

6.1 Product Outline and Installation Dimensions and Weight

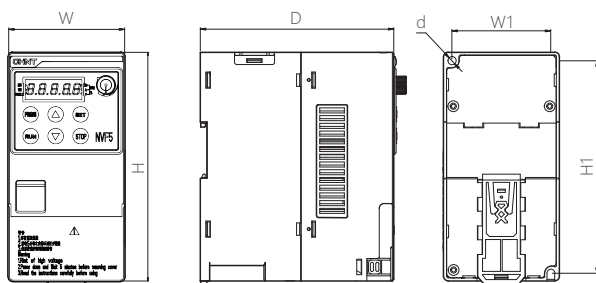

Figure 6-1 Outline and installation dimensional drawing of NVF5-0.4/TD2~NVF5-2.2/TD2 and NVF5-0.4/TS4-B~NVF5-2.2/TS4-B,

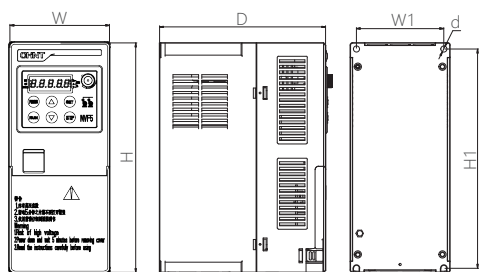

Figure 6-2 Outline and installation dimensional drawing of NVF5-3.7/TS4-B~NVF5-7.5/TS4-B,

Table 6.1 Installation dimensions and weight

Unit: mm

Model	W	H	D	W1	H1	Mounting hole d	Weight kg
NVF5-0.4/TD2	75	148	125.2	64	137.5	Φ5.3	1.2
NVF5-0.4/TD2-B							
NVF5-0.75/TD2							
NVF5-0.75/TD2-B							
NVF5-1.5/TD2							
NVF5-1.5/TD2-B	75	148	125.2	64	137.5	Φ5.3	1.25
NVF5-2.2/TD2							
NVF5-2.2/TD2-B							
NVF5-0.4/TS4-B							
NVF5-0.75/TS4-B							
NVF5-1.5/TS4-B							
NVF5-2.2/TS4-B	89.5	206	149.2	78.5	196.8	Φ5.5	1.79
NVF5-3.7/TS4-B							
NVF5-5.5/TS4-B							
NVF5-7.5/TS4-B							
NVF5-7.5/TS4-B							

6.2 External Panel and Cabinet Door Perforating Dimensions

NVF5-0.4/TD2~ NVF5-7.5/TS4-B are equipped with separate external panel interfaces which can be used for direct installation.

- a) For first option, the direct installation dimensions of the display are shown in Figure 6-5 and Figure 6-6:

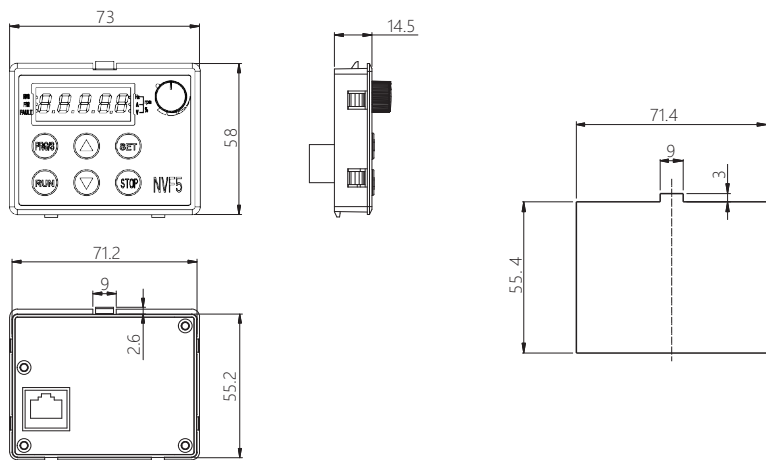

Figure 6-5 Dimensional drawing of display

Figure 6-6 Cabinet door perforating dimensions

- b) For second option, the display is mounted on the support plate. Perforate according to the dimensions of the support plate, see the dimensions in Figure 6-7 and Figure 6-8:

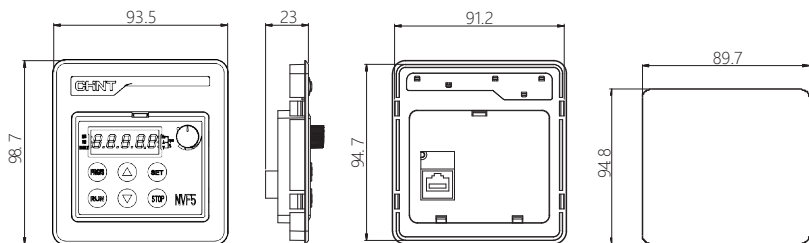

Figure 6-7 Outline dimensions of support plate

Figure 6-8 Perforating dimensions for cabinet door

7 Installation, Commissioning and Operation

7.1 Installation

7.1.1 Installation of the IP22 Protection Kit

For harsh conditions, user can install the IP22 protection kit (only for NVF5-0.4/TD2~NVF5-7.5/TS4-B) which consists of protection cover and base. See Figure 7-1 (Figure a shows the product with base; Figure b shows the product with protection cover) for installation method, see Figure 7-1 and Figure 7-2 for the outline of the product after installation.

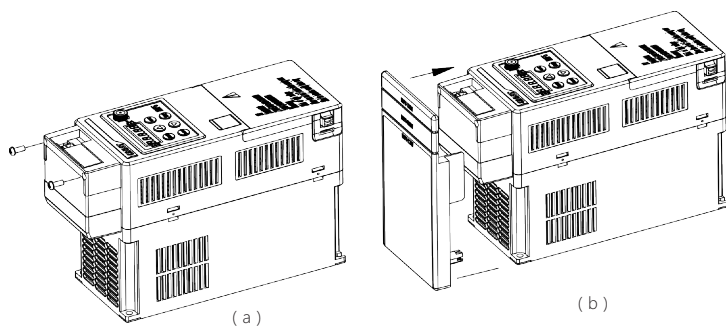

Figure 7-1 Installation diagram of IP22 protection kit

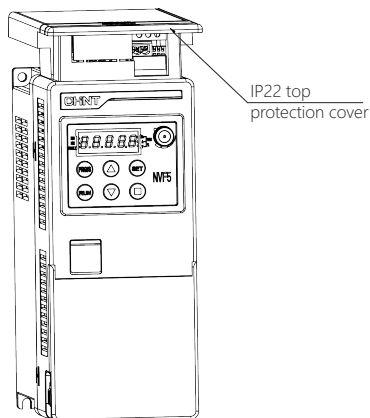

Figure 7-2 Product outline after installing IP22 protection cover

7.1.2 Usage of Upper Cover

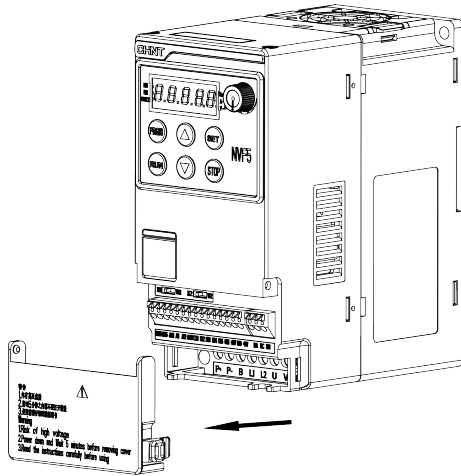

Figure 7-3 Cover usage of NVF5-0.4/TD2~NVF5-2.2/TS4-B,

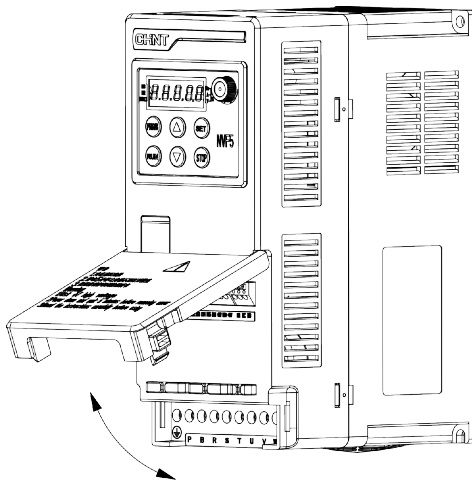

Figure 7-4 Cover usage of NVF5-3.7/TS4-B~NVF5-7.5/TS4-B

7.2 Wiring

7.2.1 Main Circuit Wiring

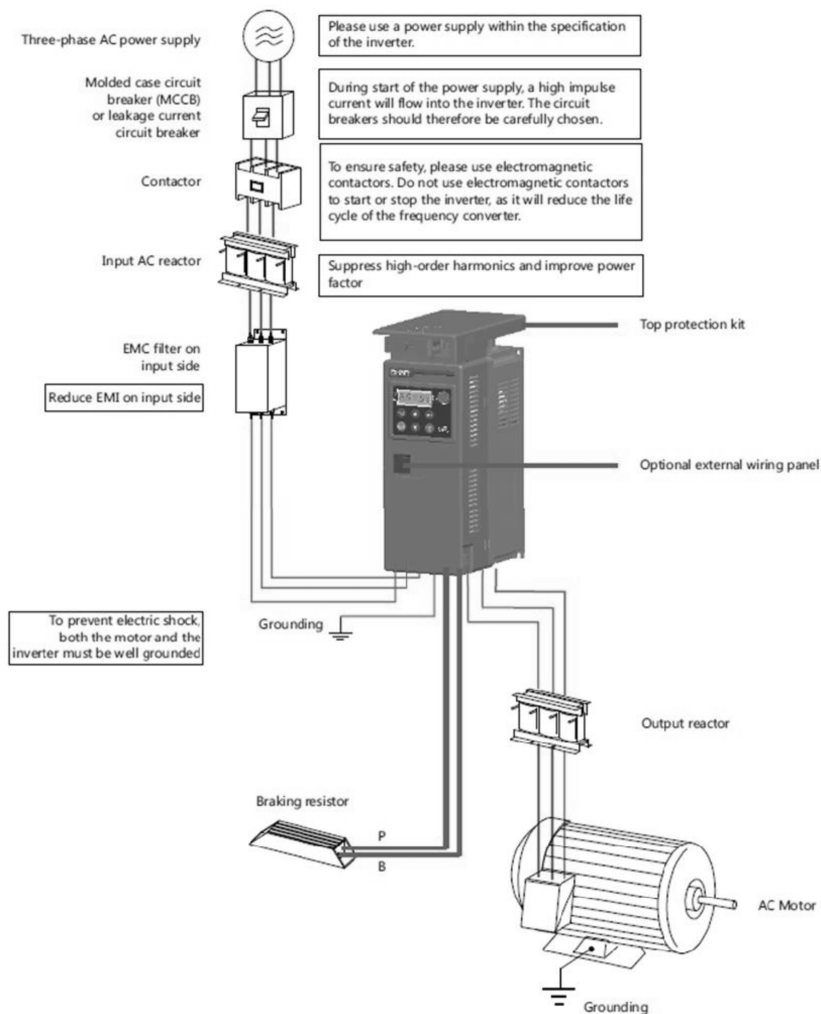

Figure 7-7 Peripheral components of main circuit

3-phase AC power	Please use power supply within the permissible range of the inverter	
Circuit breaker	When switching on the power, the inverter will suffer a large impact current, therefore user should choose the circuit breaker properly.	
Contactor	To ensure safety, please use electromagnetic contactor. Do not use the electromagnetic contactor to start or stop the inverter, otherwise it may reduce the life of the inverter.	
Input AC reactor Suppresses higher harmonics, improves power factor.		External panel option
Input noise filter Lowers the electromagnetic interference at input side		Output noise filter
Ground To prevent electric shock, motor and inverter must be grounded		Output AC reactor
Braking resistance		Motor
	Ground	

7.2.2 EMC Precautions for Wiring

Table 7.1 EMC Precautions for Wiring

Category	Precautions
Wiring inside the cabinet	Usually, the main circuit power line (strong current) and signal line (weak current) are inside the cabinet, where the signal line can be easily interfered by the power line and leads to misoperation. Therefore, the signal line and the power line should be placed in different areas, and they should not be put in the same cable trough or tied together. Leave at least a 20cm gap between the two lines. If the signal line must cross the power line, they should cross in 90 degrees. The incoming line and outgoing line of the power line should not be crossed or tied with each other.
Inverter grounding	The inverter must be grounded securely during operation, the ground line should be as short and thick as possible to lower the ground impedance to minimum level. The ground line should be far away from the input and output line of noise sensitive equipment.
Control terminal wiring of the inverter	All the connecting lines of the control terminals of the inverter are shielded lines. Use cable clip to ground the shielded layer of the shielded line in 360 degrees at the inlet of the inverter. It is prohibited to twist the shielded layer when connecting it to the inverter, otherwise the shielding effect can be significantly reduced or even completely lost.
Connection between inverter and motor	The connecting line (motor line) between inverter and motor should use shielded line or being placed in an independent cable channel. One end of the shielded layer of the motor line or the metal case of the cable trough should be connected to the inverter grounding, the other end should be connected to motor case.

7.2.3 Model Selection of Peripheral Electrical Components

Table 7.2 Model Selection of Peripheral Electrical Components

Inverter model	Rated input current A	Recommended circuit breaker A	Recommended contactor A	Wire specifications mm ²
NVF5-0.4/TD2	5.4	16	10	2.5
NVF5-0.4/TD2-B				
NVF5-0.75/TD2	10.3	25	16	2.5
NVF5-0.75/TD2-B				
NVF5-1.5/TD2	15.5	32	25	4
NVF5-1.5/TD2-B				
NVF5-2.2/TD2	20	40	32	6
NVF5-2.2/TD2-B				
NVF5-0.4/TS4-B	2.3	10	10	2.5
NVF5-0.75/TS4-B	3.3	10	10	2.5
NVF5-1.5/TS4-B	5.1	16	10	2.5
NVF5-2.2/TS4-B	6.6	16	10	4
NVF5-3.7/TS4-B	12.1	25	16	4
NVF5-5.5/TS4-B	13.1	32	25	6
NVF5-7.5/TS4-B	22.2	40	32	6

7.2.4 Model Selection of Input/Output Reactor

As an optional external device, the AC input reactor is mainly used to reduce the harmonics in input current. An AC input reactor should be installed at the input end of the inverter when the input power capacity is 5 times bigger than inverter power or there are higher harmonics exist in the environment.

The transmission line between the inverter and the motor should not be too long, otherwise higher harmonic current can easily be generated due to large volume of distributed capacity. Installing an output reactor can reduce the ground leakage current in output line, improve output efficiency and prolong the service life of inverter and motor. If the cable length is over 100m, user must install an AC output reactor at the output end of the inverter. See Table 7.3 for the model selection of input/output reactor.

Table 7.3 Model Selection of input/output reactor

Inverter model	Rated input current A	AC input reactor model	Rated output current (A)	AC output reactor model
NVF5-0.4/TS4-B	2.3	ACL-00037-AL8M40-2L	1.5	OCL-00030-ALU2100-1L
NVF5-0.75/TS4-B	3.3	ACL-00037-AL8M40-2L	2.7	OCL-00030-ALU2100-1L
NVF5-1.5/TS4-B	5.1	ACL-00050-AL4M20-2L	4.2	OCL-00050-ALU2000-1L
NVF5-2.2/TS4-B	6.6	ACL-00075-AL3M00-2L	5.8	OCL-00065-ALU1500-1L
NVF5-3.7/TS4-B	12.1	ACL-0010-AL2M20-2L	10.5	OCL-0011-ALU1200-1L
NVF5-5.5/TS4-B	13.1	ACL-0015-AL1M42-2L	13	OCL-0016-ALU900-1L
NVF5-7.5/TS4-B	22.2	ACL-0020-AL1M08-2L	17	OCL-0020-ALU700-1L

7.2.5 Model Selection of Braking Resistance

Table 7.4 Model Selection of braking resistance

Power voltage V	Inverter model	Motor power kW	Braking unit	Resistance Ω	Resistance power W
AC 230V	NVF5-0.4/TD2	0.4	Built-in (optional)	150	80
	NVF5-0.4/TD2-B				
	NVF5-0.75/TD2	0.75		150	80
	NVF5-0.75/TD2-B				
	NVF5-1.5/TD2	1.5		100	150

Table 7.4 (Continued)

Power voltage V	Inverter model	Motor power kW	Braking unit	Resistance Ω	Resistance power W
AC 230V	NVF5-1.5/TD2-B	1.5	Built-in (optional)	100	150
	NVF5-2.2/TD2	2.2		75	250
	NVF5-2.2/TD2-B				
AC 380V~440V	NVF5-0.4/TS4-B	0.4	Built-in (standard)	800	80
	NVF5-0.75/TS4-B	0.75		800	80
	NVF5-1.5/TS4-B	1.5		400	150
	NVF5-2.2/TS4-B	2.2		300	250
	NVF5-3.7/TS4-B	3.7		200	400
	NVF5-5.5/TS4-B	5.5		150	500
	NVF5-7.5/TS4-B	7.5		100	800

Note: When selecting the braking resistance, take use rate and duty into consideration. See the instructions below for the model selection of braking resistance:

a) Calculation of braking resistance

When the discharge current reaches half of the rated current of the motor, user can get a braking torque that is equal to the rated torque of the motor, therefore a rough calculation of the braking resistance can be done: $R_B = \frac{2 * U_D}{I_{MN}}$, where U_D is the braking voltage level, I_{MN} is the rated current of the motor. To prevent the inverter from being damaged, the resistance value is set to minimum R_{Bmin} when the current goes through the braking resistance is equal to rated current, any smaller value is not allowed.

$$R_{Bmin} = \frac{U_D}{I_{MN}}$$

Based on the above description, the resistance value can be chosen from: $\frac{U_D}{I_{MN}} < R \leq \frac{2 * U_D}{I_{MN}}$

b) Power calculation of braking resistance

Power consumption of braking resistance:

The power of resistance mainly depends on the use rate (ED%) of the brake. Since the braking operation is completed in a short time, therefore the temperature rise of the braking resistance is not stable, so the braking resistance capacity should be reduced to minimum as long as its temperature rise is within allowable range (rated temperature rise). See the formula below for rough calculation:

$$P_B = \lambda * P * ED\% = \lambda * \frac{U_D^2}{R} * ED\%$$

Where $\lambda = 1 - \frac{|R - R_B|}{R_B}$ is the derate coefficient of the braking resistance (usually take $\frac{1}{6}$).

R is the actual selected resistance value, P_B is the power of the braking resistance.

7.3 Use Instructions of Operation Panel

7.3.1 Keys on the panel

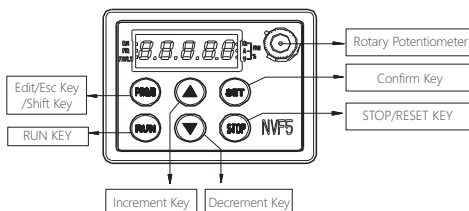











Figure 7-8 LED operation panel

Table 7.5 Functions of the keys

Keys	Functions	
	Press and hold the PRG/S key until the displayed flashing status is changed, now you can release the key and switch functions. When you are under standby mode and all the set frequencies are flashing, press and hold the PRG/S key until the displayed contents stop flashing, now you can release the key and switch functions; if any displayed content is flashing under parameter interface, press and hold PRG/S key until it stops flashing, now you can release the key and switch functions; if there is no flashing, press and hold PRG/S key until it starts to flash, now you can release the key and switch functions;	
	PRG function: enter/exit parameter sets under parameter programming status	Shift function: move the digit to be modified in circle or to the left; switch displayed parameters under main interface
	Run key	
	Stop key under normal status; reset key under fault status	
	Increase key (change group number, index number and parameter value). Use ▲ key to directly increase the set frequency after the inverter is powered on. The changing rate when you press and hold the key to alter set frequency is determined by F0.12.	
	Decrease key (change group number, index number and parameter value). Use the ▼ key to directly change the set frequency after the inverter is powered on. The changing rate when you press and hold the key to alter set frequency is determined by F0.12.	
	Confirm key (used to confirm data or operation/enter next level of menu)	
	When F0.02 = 9, user can use the potentiometer to adjust frequency. User can also change the frequency range by altering F7.12 and F7.13.	

In addition to the individual function of each key, user can also achieve other functions by press certain keys together, see Table 7.6.

Table 7.6 Functions of key combinations

Keys	Functions	
	Choose menu mode (F7.11) 1. Simple (U-1); 2. Customize (U-2); 3. Engineering (U-3).	
	System is in main interface	Lock
	In the level 1 menu of customize mode	Add customized parameter
	System is in main interface	Unlock
	In the level 1 menu of customize mode	Delete customized parameter

7.3.2 Indicators

There are 5 digits, 3 unit indicators and 3 status indicators on the LED operation panel of the inverter.

The 3 unit indicators shows Hz, A, V respectively, see Figure 7-9.

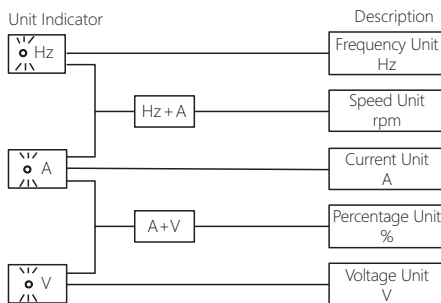

Figure 7-9 Unit indicators

3 status indicators: see Table 7.7 for definitions.

Table 7.7 Explanations of status indicators

Indicators	Status	Definitions
Run status indicator (RUN)	On	Inverter is running
	Off	Inverter is off
Direction indicator (F/R)	On	Inverter is running in default direction
	Off	Inverter is running in reverse direction
Fault indicator (FAULT)	On	Inverter is in fault status
	Off	Inverter is in normal status

7.4 Menu Operation Mode

7.4.1 Introduction of Menu Operation Mode

NVF5 has three menu operation modes for user to find and use parameter function code fast and easily.

Simple mode: Includes all basic commissioning parameters (see the introduction of simple mode in 7.6 for specific parameters). It is suitable to applications with simple motor configurations.

Customize mode: Users can customize application parameters based on their needs. There is no preset parameters in default status, users can customize the settings according to the specific introductions in 7.4.3.

Engineering mode: Includes all the parameters of the inverter (see appendix for details). It enables commissioning personnel to carry out more professional commissioning of the inverter. See Chapter Six for detailed instructions for function commissioning.

7.4.2 Selection of Menu Mode

The inverter has three menu modes, the default mode is Simple. User can select different menu mode by changing F7.11 or using key combination (PRG/S key+SET key).

- Use key combinations to alter menu mode as shown in Figure 7-10:

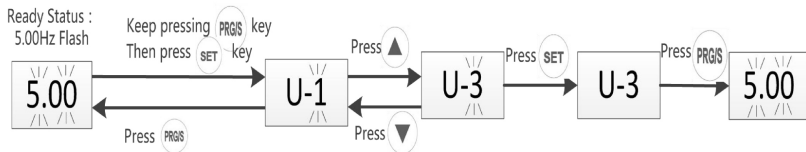

Figure 7-10 Use key combinations to select menu mode

b) Select menu mode by changing F7.11 as shown in Table 7.8:

Table 7.8 Menu mode selection table

Function code	Name	Parameter introductions	Default value
F7.11	Menu mode selection	1.Simple mode (U-1); 2.Customize mode (U-2); 3.Engineering mode (U-3);	1

See Figure 7-11 for example of changing menu mode in simple mode menu:

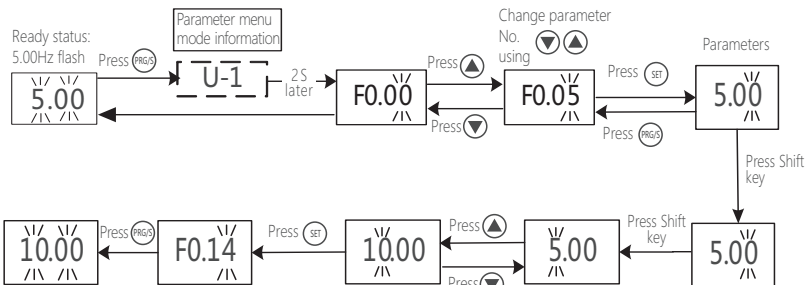

Figure 7-11 Example of changing menu mode in simple mode menu

7.4.3 Function Parameter Setup in Three Menu Modes

a) See Figure 7-12 for function parameter setup in Simple menu mode:

The figure below shows how to set parameters in Simple menu mode by taking the alteration of set frequency F0.05 as example (changing from 5.00Hz to 10.00Hz).

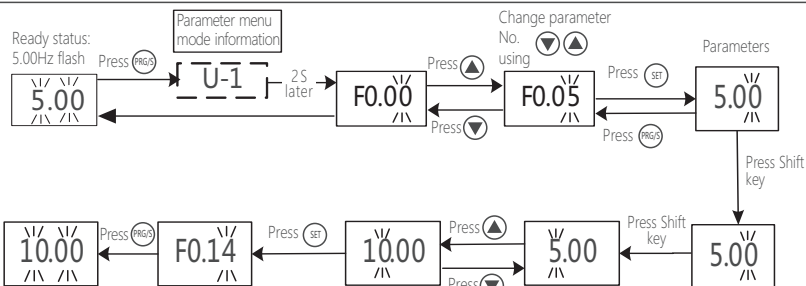

Figure 7-12 Parameter setup in Simple menu mode

b) Parameter table management in Customize menu mode

Use can customize its own parameter table in this mode. There are no preset parameters in default status, therefore user has to add parameters by itself when using the customize mode for the first time.

The figure below shows how to add parameters in customize parameter table by taking the addition of F0.00 and F1.02 in Customize menu as example, as shown in Figure 7-13.

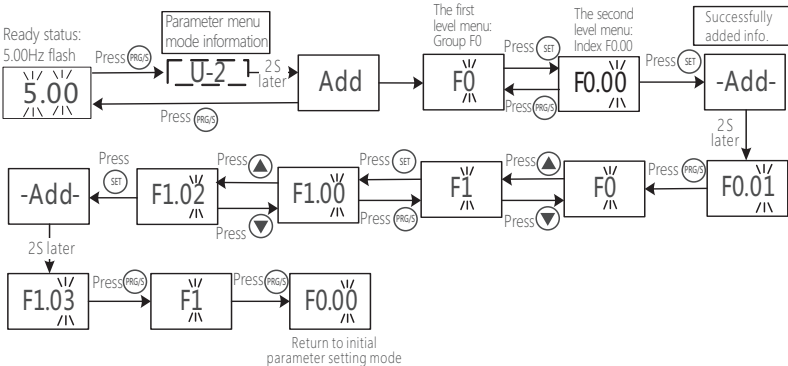

Figure 7-13 Add parameters for the first time in Customize menu mode

If user wants to check or alter the F0.00 and F1.02 parameters that have been added into the Customize menu mode, it can refer to the relevant operation instructions for Simple menu mode as shown in Figure 7-14. If user wants to delete a parameter or add another parameter, please follow the instructions below:

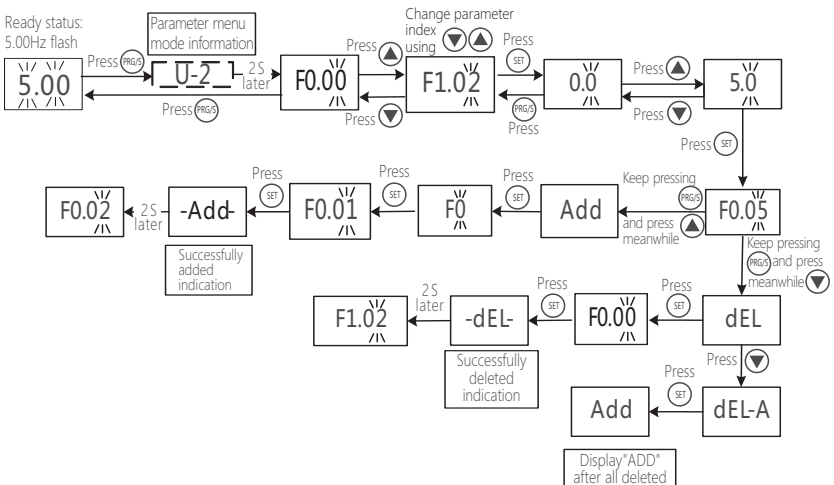

Figure 7-14 Parameter management in Customize menu mode

c) Parameter setup in engineering menu mode

The Engineering menu mode includes all parameters (see appendix 12), it enables professionals to achieve more professional commissioning and application of the inverter.

The figure below shows how to change set frequency F0.05 (changing from 5.00Hz to 10.00Hz) in Engineering menu mode. The alteration of other modifiable parameters can be done in the same manner.

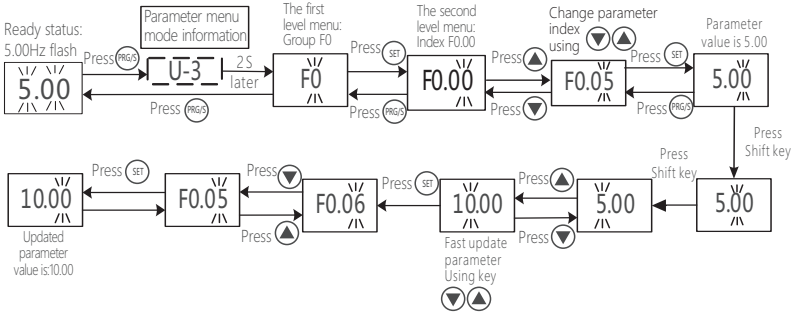





Figure 7-15 Parameter setup in Engineering menu mode

7.5 Keyboard Lockout and Password Setup

7.5.1 Keyboard Lockout

Table 7.9 Key lock/unlock instructions

Press key/parameter	Function	
Set F7.01	0: no lockout 1: full lockout 2: reserve 3: full lockout except PRG/S key (SHIFT function) 4: full lockout except RUN, STOP key	
 + 	System is in main interface	Lockout key combination
 + 	System is in main interface	Unlock key combination

The display panel will show LOC1 after user pressing the lockout key combination; the display panel will show UNLOC after user pressing the unlock key combination.

7.5.2 Keyboard Password Setup

F7.00	User password	0000: no password Other: password protection
-------	---------------	---

When F7.00 is set to any value except 0, it became user password. The password protection will come into effect as soon as you exit the code editing interface, and the display will show P.SET. Press the PRG/S key again to enter the code editing interface, the display will show "0000". User must enter the right password to enter the code editing interface. After entering the right password, the inverter will be lockout again if no keys are pressed within 1 minute. If the password is cleared, the display will show P.Clr. (If user forgets its password, please contact us for technical support.)

7.6 Simple Mode Menu and Basic Commissioning Process

7.6.1 See Table 7.10 for Simple Mode Menu

Table 7.10 Simple mode menu

Function code	Name	Attribute	Explanation	Default value
F0.00	Select control mode	⊗	0:Sensorless Vector Control; 1: reserve ; 2: V/F control	2
F0.01	Select run command channel	○	0: keyboard control 1: terminal control (default terminal function: DI1 forward rotate, DI2 reverse rotate, DI3 decelerate stop, DI4 coast stop) 2: communication control 3: external remote panel control	0
F0.02	Select main frequency source	○	0: digital reference setup; 1: AI1; 2: AI2; 3: reserve; 4: given high speed pulse HDI; 5: multi-segment command; 6: simple PLC; 7: closed loop PID; 8: reserve; 9: rotational potentiometer	0
F0.05	Digital reference setup	○	F0.09~F0.08	5.00Hz
F0.06	Motor running direction	○	0: default; 1: reserve; 2: reserve prohibited	0
F0.07	Max. output frequency	○	F0.08~600.00Hz	50.00Hz
F0.08	Upper limit of running frequency	○	F0.09~F0.07	50.00Hz
F0.09	Lower limit of running frequency	○	0.00Hz~F0.08	0.00Hz
F0.14	Acceleration time 1	○	(0.0~6500.0)s	Depends on model
F0.15	Deceleration time 1	○	(0.0~6500.0)s	Depends on model
F0.20	Parameter Factory Default	⊗	0: invalid operation 1: clear fault record (includes all fault records and accumulative total power) 2: set to factory default (except motor parameters and F7.11) 3: reset customize parameters to factory default (except F7.11 and motor parameters) 4: reset all parameters to factory default 5: backup parameters 6: use backup parameters 7: save backup parameters Note: User can only save backup parameters when using them, otherwise except for those parameters that have been revised, other parameters will remain unchanged when the device is powered on after a power failure.	0
F2.00	Select motor type	○	0: asynchronous motor; 1: reserve; 2: reserve	0
F2.01	Motor rated power	⊗	(0.1~1000.0) kW	Depends on model
F2.02	Motor rated voltage	⊗	0V~inverter rated voltage	Depends on model
F2.03	Motor rated current	⊗	(0.1~1000.0)A	Depends on model

Table 7.10 (Continued)

Function code	Name	Attribute	Explanation	Default value
F2.04	Motor rated frequency	⊙	0.01Hz ~ F0.07	Depends on model
F2.05	Motor pole number	⊙	2~24	4
F2.06	Motor rated rotation speed	⊙	(0~60000)rpm	1430rpm
F2.22	Motor parameter Auto-Tuning	⊙	0: no operation; 1: motor static Auto-Tuning; 2: motor rotate Auto-Tuning	0
F7.11	Select menu mode	⊙	1: Simple mode 2: Customize mode 3: Engineering mode	1

7.6.2 Basic Commissioning Process

See Figure 7-16 for basic commissioning operations

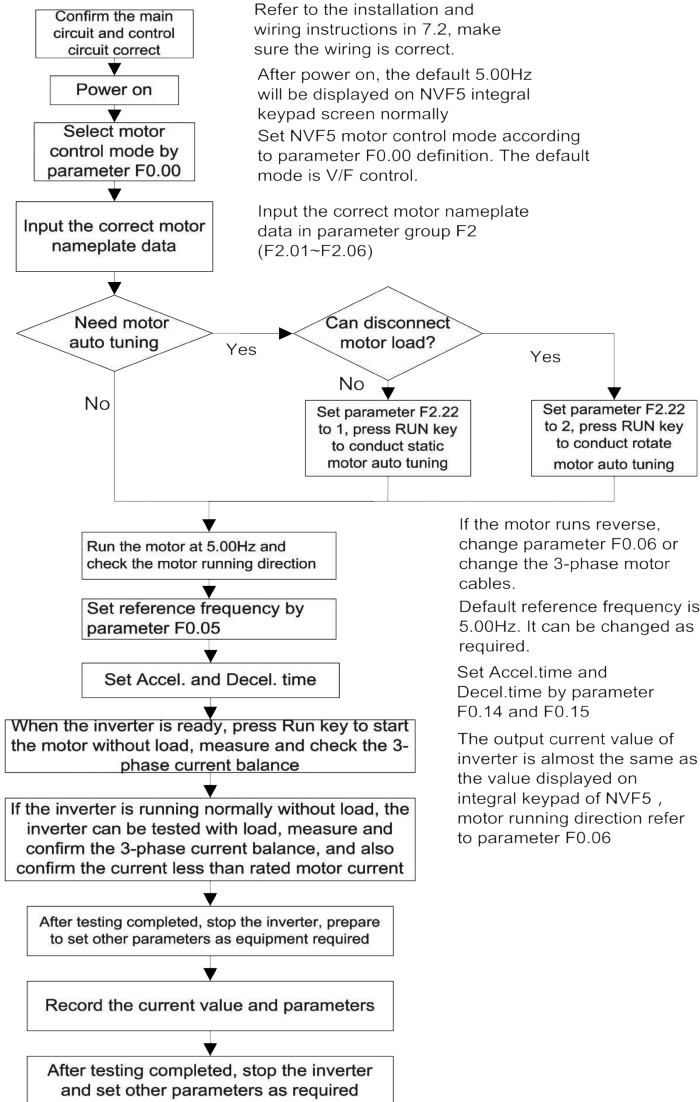

Figure 7-16 Diagram for basic commissioning

8 Notes for Maintenance, Care and Storage Commissioning and Operation

8.1 Daily Maintenance and Care

The inverter must run within specified conditions. Unexpected situations may occur during the operation. User should conduct daily maintenance and care according to Table 8.1. Keeping a good operation environment, recording all the daily operation data and identifying abnormalities in early stage would help to prolong the service life of the inverter.

Table 8.1 Daily inspection list

Target	Key points			Standard
	Content	Cycle	Measure	
Running conditions	1. Temperature, humidity	Any time	1. Thermometer, hygrometer	1. (-10~+45)°C, derate for (45~50)°C
	2. Dust, water and leakage		2. Visual	2. No sign of leakage
	3. Gas		3. Smell	3. No odor
Inverter	1. Vibration, heat generation	Any time	1. Touch enclosure	1. Stable vibration; the temperature of the fan is within reasonable range
	2. Noise		2. Hear	2. No abnormal sound
Motor	1. Heat generation	Any time	1. Touch by hand	1. No abnormality
	2. Noise		2. Hear	2. Noise is even
Running parameters	1. Output current	Any time	1. Amperemeter	1. Within rated value range
	2. Output voltage		2. Voltmeter	2. Within rated value range
	3. Internal temperature		3. Thermometer	3. Temperature rise is smaller than 35K

8.2 Maintenance and Care during Operation

- Does motor runs according to settings;
- Is there any abnormalities in the environment where the equipment is installed;
- Is there any abnormalities in the cooling system;
- Is there any abnormal vibration noise;
- Is there any overheat or color change;
- Use multimeter to measure the input voltage of the inverter during operation.

8.3 Inspection and Repair Cycle

Based on application environment, use should conduct an inspection the inverter every 3 or 6 months on a regular basis.

General inspections:

- Check if the screws of control terminals are loose. If yes, use screwdriver to tighten them;
- Check the contact status of main circuit terminals. Check if there is any sign of overheat at the connections of copper bar;
- Check if the power cables and control cables are damaged, especially any scratching on the cable sheath that contact with metal surface;
- Check the status of the insulation tapes of power cables;
- Clean up the dust on circuit board and air duct (it is preferred to use a vacuum cleaner);
- Conduct insulation test on the inverter. All the input and output terminals (R, S, T, U, V, W, etc.) in the main circuit must be short-circuited by using conductors before conducting grounding test. It is prohibited to conduct grounding test on single terminal, otherwise the inverter can be damaged. Please use 500V megameter for the test;

g) When conducting insulation test on the motor, user must remove the input terminals U, V and W from the inverter first, then test the motor separately, otherwise the inverter can be damaged.

8.4 Maintenance and Care for Long Term Idle

User must follow the instructions below for short-term and long-term storage of the inverter:

a) The inverter must be kept in a well-ventilated environment that is free from high temperature, high humidity, dust and metal dust;

b) For long-term idled inverters, user must power it on at least once every 2 years. Use voltage regulator to raise the voltage to rated value slowly, run the inverter for about 5 hours (without load is allowed).

8.4 Maintenance and Care for Long Term Idle

User must follow the instructions below for short-term and long-term storage of the inverter:

a) The inverter must be kept in a well-ventilated environment that is free from high temperature, high humidity, dust and metal dust;

b) For long-term idled inverters, user must power it on at least once every 2 years. Use voltage regulator to raise the voltage to rated value slowly, run the inverter for about 5 hours (without load is allowed).

8.5 Regular Inspection

User must cut off the power before conducting regular inspection and service on the inverter. Wait until there is no display of the monitor (keyboard) and the indicator of the main circuit power has gone off for 10 minutes. Switch the multimeter to DC and test P/P+. User should not start inspection before the P- DC bus voltage is below 25V, otherwise the residual voltage in the capacitors of the inverter may cause injury.

a) Cooling system: Please clean up the air filter and check the status of cooling fan.

b) Screws and bolts: Fixing parts such as screws and bolts may get loose due to vibration and temperature change, check their status and tighten them according to tightening torque if needed.

c) Check if the conductors and insulators are corroded or damaged.

d) Measure insulation resistance.

e) Check if there is any color change, odor, plumping and leakage in the filter capacitor.

8.6 Replacement of Spare Parts

The spare parts of the inverter mainly include fans and electrolytic capacitors whose life is closely related to application environment and maintenance. The life of these parts under normal conditions is shown in Table 8.2.

Table 8.2 Parts life

Parts	Cause of damage and measuring criteria	Life
Fans	Cause of damage: bearing wear, blade aging; Measuring criteria: cracking on fan blades, abnormal vibration sound upon starting;	(30000~40000) hours
Electrolytic capacitors	Cause of damage: high ambient temperature, frequent load change that cause increase in pulsating current, electrolyte aging; Measuring criteria: liquid leakage, bulge in safety valve, measuring of static capacitor, measuring of insulation resistance;	(40000~50000) hours
Relays	Cause of damage: corrosion, frequent operation; Measuring criteria: switch failure;	about 100000 times

User should not replace the wearing parts listed by itself. Please contact manufacturer to replace these parts.

9 Fault Analysis and Troubleshooting for Maintenance, Care and Storage Commissioning and Operation

9.1 Fault Analysis

See Figure 9-1 for fault diagnosis process.

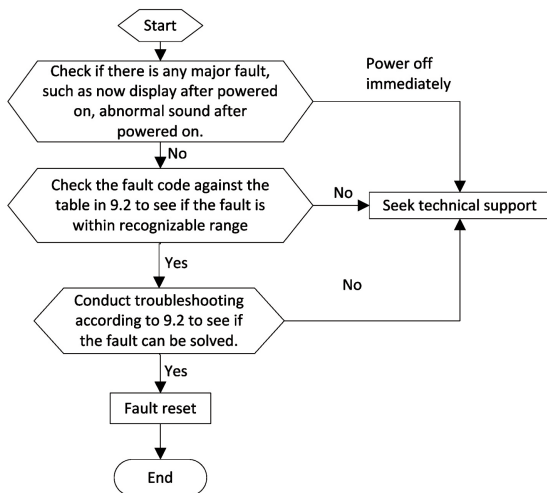

Figure 9-1 Fault analysis process

9.2 Troubleshooting

If the inverter shows the following fault codes, user can conduct troubleshooting based on the table below before seeking technical support. User should record the fault in detail and contact dealer if it needs service.

Table 9.1 Fault Codes

Fault codes	Fault types	Possible reasons	Troubleshooting measures
E.OC1	Overcurrent during inverter acceleration	1. Low voltage in grid	Check input power
		2. Direct fast start when the motor is running	Check the motor, restart the motor after it is stopped.
		3. Acceleration time is too short	Extend acceleration time
		4. Incorrect motor parameters	Conduct parameter self-tuning for the motor.
		5. Inverter power is too small	Choose an inverter with larger power
		6. Inappropriate V/F curve	Adjust V/F curve setup, adjust the increment of manual torque.
E.OC2	Overcurrent during inverter deceleration	1. Low voltage in grid	Check input power
		2. Deceleration time is too short	Extend deceleration time
		3. Potential energy load exists or load inertia torque is too big	Add suitable dynamic braking components.
		4. Inverter power is too small	Choose an inverter with larger power

Table 9.1 (Continued)

Fault codes	Fault types	Possible reasons	Troubleshooting measures
E.OC3	Overcurrent during constant speed operation of the inverter	1. The set time for acceleration and deceleration is too short	Extend acceleration and deceleration time appropriately.
		2. Sudden change or abnormality in load	Conduct load check
		3. Low voltage in grid	Check input power
		4. Inverter power is too small	Choose an inverter with larger power
E.Inv	Over Current in hardware	Similar with E.OC2,E.OC2,E.OC3	Similar Actions with E.OC2,E.OC2,E.OC3;
E.OV1	Overvoltage during inverter acceleration	1. Motor grounding short circuit	Check motor wiring
		2. Abnormal input voltage	Check input power
		3. Motor restart quickly during high speed operation	Restart motor after it is stopped
		4. The set time for acceleration is too short	Extend acceleration time appropriately
E.OV2	Overvoltage during inverter deceleration	1. Motor grounding short circuit	Check motor wiring
		2. Potential energy load exists or load inertia torque is too big	Choose suitable dynamic braking components
		3. Deceleration time is too short	Extend deceleration time
E.OV3	Overvoltage during constant speed operation of the inverter	1. Motor grounding short circuit	Check motor wiring
		2. Inappropriate ASR parameter setup in vector control operation mode	See ASR parameter setup in F3 group
		3. The set time for acceleration and deceleration is too short	Extend acceleration and deceleration time appropriately.
		4. Abnormal input voltage	Check input power
		5. Abnormal fluctuation in input voltage	Install input reactor
		6. Load inertia is too big	Consider using dynamic braking components.
E.UV	Under voltage fault	1. Sudden power loss	Fault reset
		2. Abnormal input voltage	Adjust input voltage to normal
		3. Abnormal DC voltage	Call for technical support
		4. Abnormal power bridge and buffer resistance	
		5. Abnormal in power board	
		6. Abnormal in control board	
E.SPI	Phase loss at input side	Phase loss at input R.S.T	Check wiring Check input voltage
E.SPO	Phase loss at output side	Phase loss at output U.V.W	Check output wiring Check motor and cables
E.FO	Power module protection	1. Interphase short circuit or ground short circuit at output 3 phases	Rewire, confirm the insulation of the motor is intact.
		2. Instantaneous overcurrent of inverter	See solutions for overcurrent
		3. Air duct is blocked or fan is damaged	Clean up the air duct or replace the fan.

Table 9.1 (Continued)

Fault codes	Fault types	Possible reasons	Troubleshooting measures
		4. Ambient temperature is too high	Lower ambient temperature
		5. Loose in control panel wiring or plug-in	Check and rewire
		6. Abnormal of current wave cause of phase loss.	Check the wiring
		7. Auxiliary power supply fault. Under voltage of power board.	Call for technical support.
		8. IGBT bridge broken	
		9. Abnormal of control board	
E.OH1	Over heat of colling unit.	1. Environment temperature is too high	Reduce the temperature
		2. Cooling tunnel is blocked	Clean the cooling tunnel
		3. Cooling fan broken	Change the cooling fan
		4. Abnormal of IGBT	Call for technical support.
		5. Broken of temperature detect circuit.	
E.OH2	Over heat of IGBT bridge	1. Environment temperature is too high	Reduce the temperature
		2. Cooling tunnel is blocked	Clean the cooling tunnel
		3. Cooling fan broken	Change the cooling fan
		4. Broken of temperature detect circuit.	Call for technical support.
E.OL1	Overload of motor	1. Wrong setting of parameters about motor overload protection.	Adjust the parameters
		2. Block of motor or sudden increase of motor load.	Check the load
		3. Long time running under low speed and big load.	Check the motor
		4. Low grid voltage in power supply.	Check the grid voltage
		5. V/F curve is not fitted	Adjust the right V/F curve and torque lift factors.
E.OL2	Over load of Inverter	1. Wrong setting of motor parameters	Motor parameter setting or tuning.
		2. Load is too heavy	Change to bigger inverter.
		3. DC brake is too heavy	Reduce DC brake current, longer the brake time.
		4. Short accelerate time	Longer accelerate time.
		5. Low grid voltage	Check the grid voltage.
		6. V/F curve is not fitted	Adjust the right V/F curve and torque lift factors.
E.EF	Outside fault	Outside emergency stop activated.	Check the wiring of outside terminals
E.EEP	EEPROM fault	Fault rises when read or write parameters.	STOP key reset Call for technical support

Table 9.1 (Continued)

Fault codes	Fault types	Possible reasons	Troubleshooting measures
E.CE	Abnormal of series communication	1. Abnormal of PLC or other control device.	Check the wirings
		2. Abnormal of communication cable.	Check the communication wirings.
		3. Wrong setting of communication parameters	Adjust the parameters
E.ItE	Abnormal of current detect circuit	1. Loose of control terminals	Check and rewiring
		2. Auxiliary power supply fault	Call for technical support
		3. Hall device broken.	
		4. Amplifier circuit fault	
E.tE	Auto-tuning fault.	1. Wrong setting of motor parameter.	Set the right parameters.
		2. Reversal running tuning when reversal is activated.	Cancel the reversal running forbidden.
		3. Bad connection to motor side.	Check the motor connection.
		4. Time-out of Auto-tuning	Check F0.08 (up-limit of running frequency).
E.StG	Motor-grand shorten fault	Motor-Ground Shorten	Check the motor and wiring
E.LL	Load off fault	Inverter running current less than FE.18	Check the load situation or check the settings of FE.17、FE.18、FE.19
E.FbL	PID feedback loss during operation	The PID feedback of the inverter is smaller than the set value of F9.26	Check PID feedback signal or set F9.26, F9.27 to reasonable values.
E.OT	Motor overheat	1. Loose connection of motor temperature sensor	Check the connection of motor temperature sensor.
		2. Motor overheat	Increase Switching frequency or take other heat dissipation measures for the motor.
E.SHt	Contactora fault	Power board or power supply fault	Change power board or drive board
E.CbC	Current limitation fault	Load is too heavy or motor is blocked.	Reduce the load and check the motor and load
		The inverter power is small	Change to a bigger inverter.
E.dEv	Gas of speed is too bigger	Wrong setting of F0.00	Adjust the setting of F0.00
E.OS	Exceed speed of motor (retained)		

Troubleshooting for water supply related functions

E.FbL	PID feedback loss during operation	The PID feedback of the inverter is smaller than the set value of F9.26	Check PID feedback signal or set F9.26, F9.27 to reasonable values.
E.OT	Motor overheat	1. Loose connection of motor temperature sensor	Check the connection of motor temperature sensor.
		2. Motor overheat	Increase Switching frequency or take other heat dissipation measures for the motor.

Fault display	Fault types	Possible reasons	Solutions
E.OP	Overpressure	Line water pressure exceeds the overpressure protection value (FG.17)	Check if the line water pressure exceeds limit.
		Remote pressure gauge is broken	Check if the remote pressure gauge is intact.
		Water pressure is restored to normal after overpressure	Press STOP key to recover from the fault and restart the inverter.
		Inverter fault	Power off the inverter and restart it.
E.AF	Relay operation fault	Relay operation logic error which leads to interlock	Check relay function setup (FG.03/FG.04)
			Remove the extension card and insert it back into the main control board securely.
			Power off the inverter and restart it.
E.CE1	Communication fault	The communication between water supply dedicated extension card and the main control board is off.	Remove the extension card and insert it back into the main control board securely.
			Check if the wiring is broken.
			Power off the inverter and restart it.
E.SF	Relay function setup error	Relay function setup error	The the relay function setup (FG.03/FG.04)
E.CnC	Extension card does not match	Use water supply funtion for the first time.	Power off and restart.
		Extension card does not match	Check if the extension card is suitable
		Version does not match.	Check the connections. Contact professionals for a matching version.

 Note	<p>When fault occurs, the system will stop all the pumps and display fault code; the interval for each pump to be disconnected in case of fault shut down can be set through FG.19.</p> <p>After power off, the system will stop completely.</p>
--	--

10 Environmental Protection

In order to protect the environment, the product or product parts should be disposed of according to the industrial waste treatment process, or be sent to the recycling station for assortment, dismantling and recycling according to local regulations.

11 Product Model Selection and Order Information

Model	Supported series	Description
NVF5-KP01	NVF5 full range	NVF5 standard external reference operation panel
NVF5-TB	NVF5 full range	NVF5 operation panel tray
NVF3CAB-2	NVF3, NVF5 series	Outer control panel data cable, 2 m
NVF3CAB-4	NVF3, NVF5 series	Outer control panel data cable, 4 meters

Connection terminal for braking resistance

12 Appendix Protection

12.1 Parameter Summary Table

Item	Explanation																																										
Function code	Number of function parameter groups and parameters																																										
Name	Full name of function parameter																																										
Parameter explanation	Detailed description of function parameter																																										
Units	Unit explanation:																																										
	<table border="1"> <thead> <tr> <th>Unit</th> <th>Name</th> <th>Unit</th> <th>Name</th> <th>Unit</th> <th>Name</th> </tr> </thead> <tbody> <tr> <td>V</td> <td>Voltage</td> <td>A</td> <td>Current</td> <td>°C</td> <td>Centigrade</td> </tr> <tr> <td>mH</td> <td>Millihenry</td> <td>rpm</td> <td>Rotation speed</td> <td>Ω</td> <td>Ohm</td> </tr> <tr> <td>%</td> <td>Percentage</td> <td>Hz</td> <td>Hertz</td> <td>kHz</td> <td>Kilohertz</td> </tr> <tr> <td>kW</td> <td>Kilowatt</td> <td>ms</td> <td>Millisecond</td> <td>s</td> <td>Second</td> </tr> <tr> <td>min</td> <td>Minute</td> <td>H</td> <td>Hour</td> <td>kh</td> <td>Kilohour</td> </tr> <tr> <td>bps</td> <td>Baud rate</td> <td>/</td> <td>None</td> <td></td> <td></td> </tr> </tbody> </table>	Unit	Name	Unit	Name	Unit	Name	V	Voltage	A	Current	°C	Centigrade	mH	Millihenry	rpm	Rotation speed	Ω	Ohm	%	Percentage	Hz	Hertz	kHz	Kilohertz	kW	Kilowatt	ms	Millisecond	s	Second	min	Minute	H	Hour	kh	Kilohour	bps	Baud rate	/	None		
	Unit	Name	Unit	Name	Unit	Name																																					
	V	Voltage	A	Current	°C	Centigrade																																					
	mH	Millihenry	rpm	Rotation speed	Ω	Ohm																																					
	%	Percentage	Hz	Hertz	kHz	Kilohertz																																					
	kW	Kilowatt	ms	Millisecond	s	Second																																					
min	Minute	H	Hour	kh	Kilohour																																						
bps	Baud rate	/	None																																								
Default value	Factory set value of function parameter.																																										
Alteration	The alteration attribute of function parameters (whether the parameter is allowed to be altered and the conditions for alteration)																																										
	○ Means the value of the parameter can be altered no matter the inverter is on or off.																																										
	⊗ Means the value of the parameter can only be altered in standby status.																																										
	● Means the value of the parameter is actual measured value which cannot be altered; (the inverter will automatically check the alteration attribute of each parameter to prevent user from misoperation.)																																										

a. Most parameters use decimal system (DEC), if the parameter starts with "0x", it means the parameter uses hexadecimal system (such as 0x0000). When editing parameters, the value range of some digits can use hexadecimal system (0~F).

b. "Default value" is the value of a function code parameter when it is restored to factory set value; however, the actual measured parameters or recorded values cannot be restored to factory set value.

c. The inverter offers password protection function to effectively protect parameters. See the panel operation example in 7.3 for setup method.

Function code	Name	Value range	Default value	Alteration
F0 group: Basic functions				
F0.00	Motor control mode	0: Sensorless Vector Control 1: reserve 2: V/F control	2	⊗
F0.01	Select running command channel	0: keyboard control 1: terminal control 2: communication control 3: external remote panel	0	○
F0.02	Select main frequency source	0: digital reference setup 3: reserve 5: multi-segment command 7: closed loop PID 9: rotational potentiometer 1: AI1 2: AI2 4: given high speed pulse HDI 6: simple PLC 8: reserve	0	○

Function code	Name	Value range	Default value	Alteration
F0.03	Select auxiliary frequency source	Same as F0.02(Select main frequency source)	0	○
F0.04	Calculation of main and auxiliary frequency source	Ones: Select frequency source 0: main frequency source 1: calculation result Tens: calculation of main and auxiliary frequency source 0: main + auxiliary 1: main - auxiliary 2: maximum of the two values MAX 3: minimum of the two values MIN	0x0000	○
F0.05	Digital reference setup	F0.09 ~ F0.08	5.00Hz	○
F0.06	Running direction setup	0: run in default direction 1: run in reserve direction 2: run in reserve direction prohibited	0	○
F0.07	Max. output frequency	F0.08 ~ 600.00Hz	50.00 Hz	⊗
F0.08	Running frequency upper limit	F0.09 ~ F0.07	50.00 Hz	○
F0.09	Running frequency lower limit	0.00Hz ~ F0.08	0.00 Hz	○
F0.10	Basic running frequency	0.00Hz ~ F0.07	50.00 Hz	○
F0.11	Max. output voltage	(0 ~ 480)V	Depends on inverter series	●
F0.12	Panel UP/DN speed adjustment	(0.01 ~ 99.99)Hz/s	1.00 Hz/s	○
F0.13	UP/DN control adjustment	Ones: after changing frequency by using UP/DN on the panel 0: do not save the frequency upon power off 1: save the frequency upon power off Tens: after changing frequency by using UP/DN on the panel 0: maintain the frequency upon shut down 1: restore to initial frequency upon shut down Hundreds: after changing frequency by using UP/DN on the terminal 0: do not save the frequency upon power off 1: save the frequency upon power off Thousands: after changing frequency by using UP/DN on the terminal 0: maintain the frequency upon shut down 1: restore to initial frequency upon shut down	0x0000	○
F0.14	Acceleration time 1	(0.0 ~ 6500.0)s	Depends on model	○
F0.15	Deceleration time 1	(0.0 ~ 6500.0)s	Depends on model	○
F0.16	Switching frequency	(0.5 ~ 16.0)kHz	Depends on model	○
F0.17	Self-tuning of Switching frequency	0: no 1: yes	1	○
F0.18	Reserve	0 ~ 3	0	⊗
F0.19	Automatic voltage regulation (AVR)	0: invalid 1: valid all time 2: only valid during deceleration	0	○

Function code	Name	Value range	Default value	Alteration
F0.20	Parameter Factory Default	0: invalid operation 1: clear fault record (includes all fault records and accumulative total power) 2: set to factory default (except motor parameters and F7.11) 3: reset customize parameters to factory default) (except F7.11 and motor parameters) 4: reset all parameters to factory default 5: backup parameters 6: use backup parameters 7: save backup parameters Note: User can only save backup parameters when using it, otherwise other parameters will not change after you restore power after a power failure, except for those parameters you have already changed.	0	⊗
F1 group: start and stop control group				
F1.00	Start mode	0 : start from initial frequency 1 : brake first before starting from initial frequency 2:speed tracking (including direction identification) and restart	0	○
F1.01	Initial frequency for direct start	(0.00 ~ 10.00)Hz	0.00Hz	○
F1.02	Start frequency hold time	(0.0 ~ 100.0)s	0.0s	⊗
F1.03	DC braking current before start	(0.0 ~ 100.0)%(rated current of the inverter)	0.0%	⊗
F1.04	DC braking time before start	(0.0 ~ 100.0)s	0.0s	⊗
F1.05	Stop mode	0: decelerate ramp stop 1: coast stop 2: decelerate ramp stop+DC braking	0	○
F1.06	Initial frequency of DC braking	0.00Hz ~ F0.07	0.00Hz	○
F1.07	Waiting time for DC braking	(0.0 ~ 100.0)s	0.0s	○
F1.08	DC braking current	(0.0 ~ 100.0)%(rated current of the inverter)	0.0%	○
F1.09	DC braking time	(0.00 ~ 100.0)s	0.0s	○
F1.10	Dead time for forward and reserve rotation	(0.0 ~ 300.0)s	0.0s	○
F1.11	Forward and reserve rotation switch	0: switch at running frequency lower limit F0.09 1: switch at starting frequency F1.01	0	○
F1.12	Select acceleration and deceleration methods	0: linear 1: S curve 1 2: S curve 2	0	⊗
F1.13	Time proportion of S curve starting period	(0.0 ~ 100.0)%	30.0%	⊗
F1.14	Time proportion of S curve ending period	(0.0 ~ 100.0)%	30.0%	⊗
F2 group: parameter set of primary motor				
F2.00	Select motor type	0: asynchronous motor 1: reserve 2: reserve	0	⊗
F2.01	Motor rated power	(0.1 ~ 1000.0)kW	Depends on model	⊗

Function code	Name	Value range	Default value	Alteration
F2.02	Motor rated voltage	0V ~ rated voltage of the inverter	Depends on model	⊗
F2.03	Motor rated current	(0.01 ~ 1000.00)A	Depends on model	⊗
F2.04	Motor rated frequency	0.01Hz ~ max. output frequency F0.07	Depends on model	⊗
F2.05	Motor pole number	2 ~ 24	Depends on model	⊗
F2.06	Motor rated rotation speed	(0 ~ 60000)rpm	1430	⊗
F2.07	Stator resistance of asynchronous motor	(0.001 ~ 65.535) Ω (inverter power \leq 55kW) (0.0001 ~ 6.5535) Ω (inverter power $>$ 55kW)	Depends on model	⊗
F2.08	Rotor resistance of asynchronous motor	(0.001 ~ 65.535) Ω (inverter power \leq 55kW) (0.0001 ~ 6.5535) Ω (inverter power $>$ 55kW)	Depends on model	⊗
F2.09	Leakage inductive reactance of asynchronous motor	(0.01 ~ 655.35)mH(inverter power \leq 55kW) (0.001 ~ 65.535)mH(inverter power $>$ 55kW)	Depends on model	⊗
F2.10	Mutual inductive reactance of asynchronous motor	(0.1 ~ 6553.5)mH(inverter power \leq 55kW) (0.01 ~ 655.35)mH(inverter power $>$ 55kW)	Depends on model	⊗
F2.11	Empty load current of asynchronous motor	0.01A ~ F2.03(inverter power \leq 55kW) 0.1A ~ F2.03(inverter power $>$ 55kW)	Depends on model	⊗
F2.22	Motor parameter Auto-Tuning	0: no operation 1: motor static Auto-Tuning 2: motor Rotate Auto-Tuning	0	⊗
F3 group: vector control group of primary motor				
F3.00	Speed/torque control mode	0: speed control mode 1: torque control mode	0	⊗
F3.01	Speed loop proportional gain 1 (low speed ASR1-P)	1 ~ 100	30	○
F3.02	Speed loop integral time 1 (low speed ASR1-I)	(0.01 ~ 10.00) s	0.50s	○
F3.03	Switching frequency 1	0 ~ F3.06	5.00Hz	○
F3.04	Speed loop proportional gain 2 (high speed ASR2-P)	1 ~ 100	20	○
F3.05	Speed loop integral time 2 (high speed ASR2-I)	(0.01 ~ 10.00) s	1.00s	○
F3.06	Switching frequency 2	F3.03 ~ max. output frequency F0.07	10.00Hz	○
F3.07	Vector control slip compensation coefficient	(50 ~ 200) %	100%	○
F3.08	Speed loop filtering time constant	(0.000 ~ 0.100)s	0.000s	○
F3.09	Upper limit of speed control driving torque	(0.0 ~ 300.0) %	180.0%	○
F3.10	Upper limit of speed control braking torque	(0.0 ~ 300.0) %	180.0%	○
F3.11	Excitation regulation proportional gain Kp	0 ~ 60000	2000	○
F3.12	Excitation regulation integral gain Ki	0 ~ 60000	1300	○

Function code	Name	Value range	Default value	Alteration
F3.13	Torque regulation proportional gain Kp	0 ~ 60000	2000	○
F3.14	Torque regulation integral gain Ki	0 ~ 60000	1300	○
F3.19	Select given torque	0: setup torque by keyboard 1: AI1 2: AI2 3: reserve 4: given HDI high speed pulse 5: reserve 6: MIN(AI1 , AI2) 7: Max(AI1 , AI2)	0	⊗
F3.20	Setup torque by keyboard	(-300.0 ~ + 300.0)%	0.0%	○
F3.21	Speed→torque switching point	(0.0 ~ 300.0) %(initially set torque)	100.0%	○
F3.22	Delay time for speed-torque switching	(0 ~ 1000)ms	0ms	○
F3.23	Torque given filtering time	(0 ~ 65535)s	0 s	○
F3.24	Torque control acceleration time	(0.00 ~ 650.00)s	0.10s	○
F3.25	Torque control deceleration time	(0.00 ~ 650.00)s	0.10s	○
F3.26	Speed limit for forward rotation during torque control	(0.0~100.0)%	100.0%	○
F3.27	Speed limit for reserve rotation during torque control	(0.0~100.0)%	100.0%	○
F4 group: VF control group				
F4.00	Select V/F curve	0: linear V/F curve 1: 2nd power reduced torque V/F curve 2: 1.7th power reduced torque V/F curve 3: 1.2th power reduced torque V/F curve 4: Multipoint V/F curve (set in F4.03~F4.08) 5: V/F separation curve (set in F4.12~F4.17)	0	⊗
F4.01	Torque boost	0.0%(auto) (0.1 ~ 30.0%)(relative to motor rated voltage)	Depends on model	⊗
F4.02	Limited frequency of torque boost	0.00Hz ~ max. output frequency F0.07	50.00Hz	⊗
F4.03	Multipoint VF frequency point 3	F4.05 ~ F2.04	0.00Hz	⊗
F4.04	Multipoint VF voltage point 3	(0.0 ~100.0)%	0.0%	⊗
F4.05	Multipoint VF frequency point 2	F4.07 ~ F4.03	0.00Hz	⊗
F4.06	Multipoint VF voltage point 2	(0.0 ~ 100.0)%	0.0%	⊗
F4.07	Multipoint VF frequency point 1	0.00 ~ F4.05	0.00Hz	⊗
F4.08	Multipoint VF voltage point 1	(0.0 ~ 100.0)%	0.0%	⊗
F4.09	VF slip compensation gain	(0.0 ~ 200.0)%	Depends on model	○
F4.10	VF overexcitation gain	0 ~ 200	0	○
F4.11	Reserve	--	--	○
F4.12	VF separation output voltage channel	0: setup voltage by keyboard 1: AI1 2: AI2 3: reserve Note: 100% corresponds to motor rated voltage	0	○

Function code	Name	Value range	Default value	Alteration
F4.13	Digital reference setup of VF separation voltage	(0.0 ~ 100.0) %	0.0%	○
F4.14	Increase time of VF separation voltage	(0.0 ~ 10.0) s	0.5s	○
F4.15	Decrease time of VF separation voltage	(0.0 ~ 10.0) s	0.5s	○
F4.16	Max. VF separation output voltage	F4.17 ~ 100.0%	100.0%	○
F4.17	Min. VF separation output voltage	0.0% ~ F4.16	0%	○
F4.18	Reserve	--	--	○
F4.19	Oscillation suppression factor 1	0 ~ 100	Depends on model	○
F4.20	Oscillation suppression factor 1 filtering	0 ~ 1000	0	○
F4.21	Oscillation suppression factor 2	0 ~ 100	Depends on model	○
F4.22	Oscillation suppression factor 2 filtering	0 ~ 1000	950	○
F4.23	Starting frequency of oscillation suppression	(0.00 ~ 600.00) Hz	2.00Hz	○
F4.24	Oscillation suppression ending load.	0% ~ 300.0%	60.0%	○
F4.25	Ending frequency of oscillation suppression.	(0.00 ~ 600.00) Hz	45.00Hz	○
F4.26	Motor slip compensate filtering factor	0 ~ 1000	100	○
F4.27	Motor slip compensate invalid frequency.	(0.00 ~ 600.00) Hz	10.00HZ	
F5 group: input terminal parameter group				
F5.00	Select HDI input type	0: HDI is high speed pulse input (set in F5.15 ~ F5.18) 1: HDI is switch input (similar to the function of terminal DI1 ~ DI4)	0	⊗
F5.01	Select DI1 terminal function	0 ~ 63	1	⊗
F5.02	Select DI2 terminal function	0: no function	2	⊗
F5.03	Select DI3 terminal function	1: forward rotation FWD 2: reserve rotation REV	9	⊗
F5.04	Select DI4 terminal function	3: forward Jog 4: reverse Jog	12	⊗
F5.05	Select HDI terminal functions	5: 3-wire running control 6: fault reset 7: external fault input 8: reserve 9: pause 10: external terminal shut down 11: deceleration DC braking 12: coast stop 13: terminal UP	0	⊗

Function code	Name	Value range	Default value	Alteration
		14: terminal DOWN 15: command switches to keyboard control 16: command switches to terminal control 17: command switches to communication control 18: main frequency source switches to given digit 19: main frequency source switches to AI1 20: main frequency source switches to AI2 21: reserve 22: main frequency source switches to HDI 23: reserve 24: multi-segment command terminal 1 25: multi-segment command terminal 2 26: multi-segment command terminal 3 27: multi-segment command terminal 4 28: acceleration and deceleration time selection terminal 1 29: acceleration and deceleration time selection terminal 2 30~33: reserve 34: forward rotation prohibited 35: reverse rotation prohibited 36: acceleration and deceleration prohibited 37: clear UP/DN setup 38: switch between speed control and Torque control 39: PLC pause 40: PLC prohibited 41: clear PLC shut down memory 42: PLC status reset 43: PID integral pause 44: PID prohibited 45: take reverse PID action direction 46: PID parameter switch 47: reserve 48: DC braking 49: frequency setup valid terminal 50: reserve 51: clear the running time of this time 52~63: reserve		
F5.06	Setup of input terminal valid status (DI1 ~ DI4, HDI)	Setup range: 0x0000 ~ 0x001F Binary system setup: 0: normal logic, breakover is valid 1: reverse logic, break is valid Ones: BIT0 ~ BIT3: DI1 ~ DI4 Tens: BIT0 : HDI BIT0 ~ BIT3 : reserve	0x0000	○
F5.07	Input terminal filtering time	(0.000 ~ 1.000)s	0.010s	○
F5.08	Select terminal control mode	0: 2-wire control mode 1 1: 2-wire control mode 2 2: 3-wire control mode 1 3: 3-wire control mode 2 4: reserve	0	⊙

Function code	Name	Value range	Default value	Alteration
F5.09	Terminal UP/DN speed	(0.001 ~ 65.535)Hz/s	1.000Hz/s	⊕
F5.10	DI1 terminal delay time	(0.000 ~ 60.000)s	0.000s	○
F5.11	DI2 terminal delay time	(0.000 ~ 60.000)s	0.000s	○
F5.12	DI3 terminal delay time	(0.000 ~ 60.000)s	0.000s	○
F5.13	DI4 terminal delay time	(0.000 ~ 60.000)s	0.000s	○
F5.14	HDI terminal delay time	(0.000 ~ 60.000)s	0.000s	○
F5.15	HDI min. input pulse	0.0 kHz ~ F5.17 Note: Only valid when high speed pulse input is selected for HDI terminal	0.0kHz	○
F5.16	Corresponding setup for HDI min. input pulse	(-100.0~100.0)%	0.0%	⊕
F5.17	HDI max. input pulse	F5.15~100.0kHz Note: only valid when high speed pulse input is selected for HDI terminal	100.0kHz	⊕
F5.18	Corresponding setup for HDI max. input pulse	(-100.0 ~ +100.0)%	100.0%	⊕
F5.19	Given pulse filtering time	(0.00 ~ 10.00)s	0.05s	○
F5.20	Reserve	--	--	○
F5.21	AI1 filter	(0.00 ~ 10.00)s	0.05s	○
F5.22	AI2 filter	(0.00 ~ 10.00)s	0.05s	○
F5.23	Reserve	--	--	○
F5.24	Select curve	Setup range: 0x0000~0x0333 Ones: select AI1 curve 0: curve 1 1: curve 2 2: curve 3 3: curve 4 Tens: select AI2 curve 0: curve 1 1: curve 2 2: curve 3 3: curve 4 Hundreds: reserve Thousands: reserve	0x0000	○
F5.25	Min. given value of curve 1	0.00V ~ F5.27	0.00V	○
F5.26	Corresponding setup of the min. given value of curve 1	(-100.0 ~ +100.0)%	0.0%	○
F5.27	Max. given value of curve 1	F5.25 ~ +11.00V	10.00V	○
F5.28	Corresponding setup of the max. given value of curve 1	(-100.0 ~ + 100.0)%	100.0%	○
F5.29	Min. given value of curve 2	0.00 ~ F5.31	0.00V	○
F5.30	Corresponding setup of the min. given value of curve 2	Same as F5.26	0.0%	○
F5.31	Max. given value of curve 2	F5.29 ~ + 11.00V	10.00V	○
F5.32	Corresponding setup of the max. given value of curve 2	Same as F5.26	100.0%	○
F5.33	Min. given value of curve 3	-10.00V ~ F5.35	-10.00V	○

Function code	Name	Value range	Default value	Alteration
F5.34	Corresponding setup of the min. given value of curve 3	(-100.0 ~ +100.0)%	-100.0%	○
F5.35	Max. given value of curve 3	F5.33 ~ + 11.00V	10.00V	○
F5.36	Corresponding setup of the max. given value of curve 3	(-100.0 ~ +100.0)%	100.0%	○
F5.37	Min. given value of curve 4	-10.0V ~ F5.39	0.00V	○
F5.38	Corresponding setup of the min. given value of curve 4	(-100.0 ~ +100.0)%	0.0%	○
F5.39	Given value of curve 4 knee point 1	F5.37 ~ F5.41	3.00V	○
F5.40	Corresponding setup of curve 4 knee point 1	(-100.0 ~ +100.0)%	30.0%	○
F5.41	Given value of curve 4 knee point 2	F5.39 ~ F5.43	6.00V	○
F5.42	Corresponding setup of curve 4 knee point 2	(-100.0 ~ +100.0)%	60.0%	○
F5.43	Max. given value of curve 4	F5.41 ~ + 11.00V	10.00V	○
F5.44	Corresponding setup of the max. given value of curve 4	(-100.0 ~ +100.0)%	100.0%	○
F5.45	Select AI/HDI lower limit	0x0000 ~ 0x0111 0: limited to Corresponding setup of min. given value 1: limited to 0.0% Ones: select AI1 lower limit Tens: select AI2 lower limit Hundreds: select HDI lower limit Thousands: reserve	0x0000	○
F5.46	AI1 measured voltage 1	(-10.000~ +10.000)V	2.000V	○
F5.47	AI1 displayed voltage 1	(-10.000~ +10.000)V	2.000V	○
F5.48	AI1 measured voltage 2	(-10.000~ +10.000)V	8.000V	○
F5.49	AI1 displayed voltage 2	(-10.000~ +10.000)V	8.000V	○
F5.50	AI2 measured voltage 1	(-10.000~ +10.000)V	2.000V	○
F5.51	AI2 displayed voltage 1	(-10.000~ +10.000)V	2.000V	○
F5.52	AI2 measured voltage 2	(-10.000~ +10.000)V	8.000V	○
F5.53	AI2 displayed voltage 2	(-10.000~ +10.000)V	8.000V	○
F5.54	AI3 measured voltage 1	(-10.000~ +10.000)V	2.000V	○
F5.55	AI3 displayed voltage 1	(-10.000~ +10.000)V	2.000V	○
F5.56	AI3 measured voltage 2	(-10.000~ +10.000)V	8.000V	○
F5.57	AI3 displayed voltage 2	(-10.000~ +10.000)V	8.000V	○
F6 group: output terminal parameter set				
F6.00	Select HDO output type	0: open collector high speed pulse output 1: open collector output (setup by F6.01)	0	
F6.01	Select HDO output function	0 ~ 63	1	○
F6.02	Select relay RO output function	0: no output 1: inverter running	16	○
F6.03	Select relay RO2 output function	2: measured frequency level reaches FDT 3: measured frequency level reaches FDT2 4: inverter overload pre-alarm	0	○

Function code	Name	Value range	Default value	Alteration
		5: undervoltage output 6: external fault shut down 7: reaches upper frequency limit 8: reaches lower frequency limit 9: running at zero speed 10~11: reserve 12: indication for simple PLC completed 13: PLC cycle completed 14: reserve 15: inverter is ready to run 16: fault output 17~18: reserve 19: torque is limited 20: rotation speed and direction 21: PFC 22: reaches frequency 23: reserve 24: load loss 25: zero current status 26: reaches current 1 27: reaches current 2 28: reaches module temperature 29: output current exceeds limit 30: reserve 31: motor overload pre-alarm 32: reserve 33: reserve 34: reaches set time 35: AI1>AI2 36: reserve 37: reaches current running time 38~63: reserve		
F6.04	Setup of output terminal valid status (HDO, RO, RO2)	Setup range: 0x0000~0x0007 Binary system: 0: open is valid 1: break is valid Ones: BIT0~BIT1: HDO, RO, RO2 Tens: reserve	0x0000	○
F6.05	HDO output delay time	(0.0 ~ 3600.0)s	0.0s	○
F6.06	Relay output delay time	(0.0 ~ 3600.0)s	0.0s	○
F6.07	Relay 2 output delay time	(0.0 ~ 3600.0)s	0.0s	○
F6.08	Select AO1 output functions	0 ~ 36	0	○
F6.09	Select HDO output function	0: no function 1: running frequency (0~max. output frequency) 2: set frequency (0~ max. output frequency) 3: set frequency (after acceleration or deceleration)(0~ max. output frequency) 4: output rotation speed (0~ max. output frequency) 5: output current (0 ~ 2 times of inverter rated current) 6: output current 2(0 ~ 2 times of inverter rated current) 7: output (absolute value)(0~3 times of motor rated torque) 8: output power (0~2 times of motor rated power)	0	○

Function code	Name	Value range	Default value	Alteration
		9: output voltage (0~1.2 times of inverter rated voltage) 10: Bus voltage(0~1000.0V) 11: AI1 12: AI2 13: reserve 14: PULSE pulse input (0~100)kHz 15: reserve 16: reserve 17: reserve 18: output current (correspond to (0-1000)A) 19: output voltage (correspond to (0-1000)V) 20: output ((-200.0 ~ + 200.0)% motor rated torque) 21 ~ 36: reserve		
F6.10	AO1 zero-bias correction coefficient	(-100.0 ~ 100.0)%	0.0%	○
F6.11	AO1 gain	-10.0 ~ + 10.00	1.00	○
F6.12	HDO max. output pulse frequency	(0.01 ~ 100.00)kHz	10.00kHz	○
F6.13	Frequency arrival (FAR) detection width	(0.0 ~ 100.0)%	5.0%	○
F6.14	FDT1 level	0.00 Hz ~ F0.07	50.00Hz	○
F6.15	FDT1 lag	(0.0 ~ 100.0)%	5.0%	○
F6.16	FDT2 level	0.00 Hz ~ F0.07	25.00Hz	○
F6.17	FDT2 lag	(0.0 ~ 100.0)%	5.0%	○
F6.18	AO1 measured voltage 1	(-10.000~ +10.000)V	2.000V	○
F6.19	AO1 displayed voltage 1	(-10.000~ +10.000)V	2.000V	○
F6.20	AO1 measured voltage 2	(-10.000~ +10.000)V	8.000V	○
F6.21	AO1 displayed voltage 2	(-10.000~ +10.000)V	8.000V	○
F7 group: panel function group				
F7.00	User password	0000: no password Others: password protection	0000	○
F7.01	Keyboard lockout function	0: no lockout 1: full lockout 2: reserve 3: full lockout except PRG/S key (SHIFT function) 4: full lockout except RUN, STOP key	0	○
F7.02	Select functions of MF (multifunction) key Note: This function is only valid in Modbus communication panel.	0: Jogging 1: coast stop 2: fast stop 3: switch between forward and reverse rotation 4: clear UP/DN setup	0	○
F7.03	Parameter protection setup	0: all data can be altered 1: alteration is prohibited except digital reference setup (F0.05) and this function code 2: alteration is prohibited except this function code	0	⊙

Function code	Name	Value range	Default value	Alteration
F7.04	Parameter copy Note: This function is only valid in Modbus communication panel.	0: no operation 1: upload parameters 2: download parameters 3: download parameters (except motor parameters)	0	○
F7.05	Select parameters for running status display 1	Setup range: 0x0007 ~ 0xFFFF(3FFF) Bit00: output frequency (Hz on) Bit01: set frequency (Hz flash) Bit02: bus voltage (V on) Bit03: output voltage(V on) Bit04: output current (A on) Bit05: running rotation speed (rpm on) Bit06: output power(% on) Bit07: output torque (% on) Bit08: given PID (% flash) Bit09: feedback PID (% on) Bit10: input terminal status Bit11: output terminal status Bit12: set torque value (% on) Bit13: current number of segments of PLC Bit14: set rotation speed Bit15: reserve	0x0017	○
F7.06	Select parameters for running status display 2	Setup range:0x0000 ~ 0x000F Bit00: analog AI1 value (V on) Bit01: analog AI2 value (V on) Bit02: reserve Bit03: high speed pulse HDI frequency Bit04 ~ Bit15: reserve	0x0000	○
F7.07	Select parameters for stop status display	Setup range:0x0003 ~ 0x0FFF Bit00: set frequency (Hz on, frequency flashes slowly) Bit01: bus voltage (V on) Bit02: input terminal status Bit03: output terminal status Bit04: given PID (% flash) Bit05: feedback PID (% on) Bit06: set torque value (% on) Bit07: analog AI1 value (V on) Bit08: analog AI2 value (V on) Bit09: reserve Bit10: high speed pulse HDI frequency Bit11: current number of segments of PLC Bit12: set rotation speed Bit13 ~ Bit15: reserve	0x0003	○
F7.08	Select STOP key stop function	0: only valid for panel control 1: valid for all control mode	1	○
F7.09	Speed display gain	0.01%~100.00%	100.00%	○
F7.10	Reserve	--	--	○
F7.11	Select menu mode	1: Simple mode 2: Customize mode 3: Engineering mode	1	○
F7.12	Percentage of max. frequency corresponding to the min. value of panel potentiometer	0.0%~F7.13	0.0%	○

Function code	Name	Value range	Default value	Alteration
F7.13	Percentage of max. frequency corresponding to the max. value of panel potentiometer	(0.0~100.0)%	100.0%	○
F8 group: enhanced function group				
F8.00	Jogging frequency	0.10 Hz ~ max. output frequency F0.07	5.00Hz	○
F8.01	Jogging acceleration time	(0.0 ~ 6500.0)s	20.0s	○
F8.02	Jogging deceleration time	(0.0 ~ 6500.0)s	20.0s	○
F8.03	Reserve	--	0.0s	○
F8.04	Acceleration time 2	(0.0 ~ 6500.0)s	10.0s	○
F8.05	Deceleration time 2	(0.0 ~ 6500.0)s	10.0s	○
F8.06	Acceleration time 3	(0.0 ~ 6500.0)s	10.0s	○
F8.07	Deceleration time 3	(0.0 ~ 6500.0)s	10.0s	○
F8.08	Acceleration time 4	(0.0 ~ 6500.0)s	10.0s	○
F8.09	Deceleration time 4	(0.0 ~ 6500.0)s	10.0s	○
F8.10	Jump frequency 1	0.00 Hz ~ max. output frequency F0.07	0.00Hz	○
F8.11	Jump frequency 1 range	0.00 Hz ~ max. output frequency	0.00Hz	○
F8.12	Jump frequency 2	0.00 Hz ~ max. output frequency	0.00Hz	○
F8.13	Jump frequency 2 range	0.00 Hz ~ max. output frequency	0.00Hz	○
F8.14	Jump frequency 3	0.00 Hz ~ max. output frequency	0.00Hz	○
F8.15	Jump frequency 3 range	0.00 Hz ~ max. output frequency	0.00Hz	○
F8.16	Operation voltage of braking unit	(650 ~ 800)V(380V series) (320 ~ 380)V(230V series)	720V (380V series) 360V (230V series)	○
F8.17	Select dynamic braking	0: do not operate 1: operate	0	○
F8.18	Use rate of dynamic braking	(0.0 ~ 100.0)%	80.0%	○
F8.19	Threshold value for zero frequency running	(0.00 ~ 300.00)Hz	0.50Hz	○
F8.20	Zero current detection value	(0.0 ~ 300.0) %	5.0%	○
F8.21	Delay time for zero current detection	(0.00 ~ 600.00)s	0.10s	○
F8.22	Output current exceeds limit	(0.0 ~ 300.0) %	200.0%	○
F8.23	Delay time for output current over-limit detection	(0.00 ~ 600.00)s	0.00s	○
F8.24	Current arrival detection value 1	(0.0 ~ 300.0) %	100.0%	○
F8.25	Current arrival detection value 1 range	(0.0 ~ 300.0) %	0.0%	○
F8.26	Current arrival detection value 2	(0.0 ~ 300.0) %	100.0%	○
F8.27	Current arrival detection value 2 range	(0.0 ~ 300.0) %	0.0%	○
F8.28	Module temperature arrival	(0~100)°C	75°C	○
F8.29	Fan auto control	0: automatically running 1: keep running when powered on	0	⊗
F8.30	Droop control	(0.00 ~ 10.00)Hz(0.00Hz invalid)	0.00Hz	○

Function code	Name	Value range	Default value	Alteration
F8.31	Select start protection	0: without protection 1: with protection	1	○
F8.32	Select timing function	0: invalid 1: valid	0	○
F8.33	Timed running time	(0.0 ~ 6500.0)min	0.0min	○
F8.34	Current running arrival time	(0.0 ~ 6500.0)min	0.0min	○
F8.35	Select restart after power interruption	0: invalid 1: valid	0	○
F8.36	Wait time for restart after power interruption	(0.0 ~ 10.0)s	0.0s	○
F8.37	Running mode with set frequency smaller than lower frequency limit	0: run at lower frequency limit 1: deceleration stop	0	○
F8.38	Terminal Jogging is preferred	0: invalid 1: valid	0	○
F9 group: process PID control group				
F9.00	Select given channel	0: given digital reference 1: AI1 2: AI2 3: reserve 4: given high speed pulse HDI 5: reserve 6: given multi-segment command	1	⊗
F9.01	Select feedback channel	0: AI1 1: AI2 2: reserve 3: AI1+AI2 4: AI1-AI2 5: MIN(AI1, AI2) 6: MAX(AI1, AI2) 7: high speed pulse HDI 8: reserve	1	⊗
F9.02	Given digital reference setup	(0.0 ~ 100.0)%	50.0%	○
F9.03	Proportional gain KP	0.0 ~ 100.0	20.0	○
F9.04	Integral gain Ki	0.01 ~ 10.00	2.00	○
F9.05	Differential gain Kd	0.000 ~ 10.000	0.000	○
F9.06	Sampling cycle	(0.01 ~ 50.00)s	0.50s	○
F9.07	Given changing time	(0.00 ~ 650.00)s	0.00s	○
F9.08	Feedback filtering time	(0.00 ~ 60.00)s	0.00s	○
F9.09	Output filtering time	(0.00 ~ 60.00)s	0.00s	○
F9.10	Deviation limit	(0.0 ~ 100.0)%	0.0%	○
F9.11	Differential limit	(0.00 ~ 100.00)%	0.10%	○
F9.12	Max. positive offset between two outputs	(0.00 ~ 100.00)%	1.00%	○
F9.13	Max. negative offset between two outputs	(0.00 ~ 100.00)%	1.00%	○

Function code	Name	Value range	Default value	Alteration
F9.14	Select closed-loop output reversal	0: closed-loop output is negative, inverter runs at lower frequency limit 1: closed-loop output is negative, inverter runs in reverse direction	0	○
F9.15	Closed-loop regulation characteristics	0: forward direction 1: reverse direction	0	⊗
F9.16	Select integral regulation	0: stop integrating when frequency reaches upper or lower limit 1: continue integrating when frequency reaches upper or lower limit	0	○
F9.17	Proportional gain Kp2	0.0 ~ 100.0	20.0	○
F9.18	Integral time Ki2	0.01 ~ 10.00	2.00	○
F9.19	Differential time Kd2	0 ~ 10.000	0.000	○
F9.20	Conditions for parameter switch	0: does not switch 1: switched by DI terminal 2: auto switch based on deviation	0	○
F9.21	Deviation for switch 1	0.0% ~ F9.22	20.0%	○
F9.22	Deviation for switch 2	F9.21 ~ 100.0 %	80.0%	○
F9.23	Closed loop preset value	(0.0 ~ 100.0)%	0.0%	○
F9.24	Hold time for preset value	(0.00 ~ 650.00)s	0.00s	⊗
F9.25	Given feedback range	0 ~ 65535	1000	⊗
F9.26	Detection value for feedback loss	(0.0 ~ 100.0)%	0.0%	⊗
F9.27	Detection time for feedback loss	(0.0 ~ 20.0)s	0.0	○
F9.28	Closed loop calculation mode	0: does not calculation during shut down 1: calculates during shut down	0	○
F9.29	Select closed loop backup channel	0: given digital reference 1: AI1 2: AI2 3: reserve 4: given high speed pulse HDI	0	○
F9.30	Sleep function	0: invalid 1: valid	0	○
F9.31	Sleep frequency	0.00 Hz ~ F0.07	0.00Hz	○
F9.32	Sleep delayed	0.0s ~ 6500.0s	0.0s	○
F9.33	Wake up deviation	(0.0 ~ 100.0)%	0.0%	○
F9.34	Wake up delayed	(0.0 ~ 6500.0)s	0.0s	○
FA group: simple PLC and multi-segment speed control group				
FA.00	Select simple PLC running method	Setup range: 0x0000 ~ 0x0112 Ones: PLC running method 0: stop after single circle 1: maintain final value after single circle 2: continuous circle Tens: save upon stop 0: do not save 1: save the stage and frequency upon stop Hundreds: save upon power failure	0x0000	⊗

Function code	Name	Value range	Default value	Alteration
		0: do not save 1: save the stage and frequency upon power failure Thousands: select unit for stage time 0: second 1: minute		
FA.01	Stage 1 setup	Setup range : 0x0000 ~ 0x0315 Ones: frequency source 0: multistage frequency N 1: AI1 2: AI2 3: reserve 4: high speed pulse HDI 5: closed loop PID output Tens: running direction 0: forward 1: reverse Hundreds: acceleration and deceleration time 0: acceleration and deceleration time 1 1: acceleration and deceleration time 2 2: acceleration and deceleration time 3 3: acceleration and deceleration time 4	0x0000	○
FA.02	Running time of stage 1	0.0 ~ 6500.0	20.0	○
FA.03	Setup of stage 2	Same as FA.01	0x0000	○
FA.04	Running time of stage 2	0.0 ~ 6500.0	20.0	○
FA.05	Setup of stage 3	Same as FA.01	0x0000	○
FA.06	Running time of stage 3	0.0 ~ 6500.0	20.0	○
FA.07	Setup of stage 4	Same as FA.01	0x0000	○
FA.08	Running time of stage 4	0.0 ~ 6500.0	20.0	○
FA.09	Setup of stage 5	Same as FA.01	0x0000	○
FA.10	Running time of stage 5	0.0 ~ 6500.0	20.0	○
FA.11	Setup of stage 6	Same as FA.01	0x0000	○
FA.12	Running time of stage 6	0.0 ~ 6500.0	20.0	○
FA.13	Setup of stage 7	Same as FA.01	0x0000	○
FA.14	Running time of stage 7	0.0 ~ 6500.0	20.0	○
FA.15	Setup of stage 8	Same as FA.01	0x0000	○
FA.16	Running time of stage 8	0.0 ~ 6500.0	20.0	○
FA.17	Setup of stage 9	Same as FA.01	0x0000	○
FA.18	Running time of stage 9	0.0 ~ 6500.0	20.0	○
FA.19	Setup of stage 10	Same as FA.01	0x0000	○
FA.20	Running time of stage 10	0.0 ~ 6500.0	20.0	○
FA.21	Setup of stage 11	Same as FA.01	0x0000	○
FA.22	Running time of stage 11	0.0 ~ 6500.0	20.0	○
FA.23	Setup of stage 12	Same as FA.01	0x0000	○
FA.24	Running time of stage 12	0.0 ~ 6500.0	20.0	○
FA.25	Setup of stage 13	Same as FA.01	0x0000	○
FA.26	Running time of stage 13	0.0 ~ 6500.0	20.0	○
FA.27	Setup of stage 14	Same as FA.01	0x0000	○
FA.28	Running time of stage 14	0.0 ~ 6500.0	20.0	○
FA.29	Setup of stage 15	Same as FA.01	0x0000	○

Function code	Name	Value range	Default value	Alteration
FA.30	Running time of stage 15	0.0 ~ 6500.0	20.0	○
FA.31	Multi-segment command 1	(-100.0 ~ 100.0)%	0.0%	○
FA.32	Multi-segment command 2	(-100.0 ~ 100.0)%	0.0%	○
FA.33	Multi-segment command 3	(-100.0 ~ 100.0)%	0.0%	○
FA.34	Multi-segment command 4	(-100.0 ~ 100.0)%	0.0%	○
FA.35	Multi-segment command 5	(-100.0 ~ 100.0)%	0.0%	○
FA.36	Multi-segment command 6	(-100.0 ~ 100.0)%	0.0%	○
FA.37	Multi-segment command 7	(-100.0 ~ 100.0)%	0.0%	○
FA.38	Multi-segment command 8	(-100.0 ~ 100.0)%	0.0%	○
FA.39	Multi-segment command 9	(-100.0 ~ 100.0)%	0.0%	○
FA.40	Multi-segment command 10	(-100.0 ~ 100.0)%	0.0%	○
FA.41	Multi-segment command 11	(-100.0 ~ 100.0)%	0.0%	○
FA.42	Multi-segment command 12	(-100.0 ~ 100.0)%	0.0%	○
FA.43	Multi-segment command 13	(-100.0 ~ 100.0)%	0.0%	○
FA.44	Multi-segment command 14	(-100.0 ~ 100.0)%	0.0%	○
FA.45	Multi-segment command 15	(-100.0 ~ 100.0)%	0.0%	○
FA.46	Select PLC backup channel	0: given digital reference 1: AI1 2: AI2 3: reserve 4: given high speed impulse HDI	0	○
Fb group: serial communication parameter group				
Fb.00	Local communication address	1 ~ 247	10	○
Fb.01	Communication baud rate setup	0: 2400BPS 1: 4800BPS 2: 9600BPS 3: 19200BPS 4: 38400BPS	3	○
Fb.02	Digit check setup	0: no parity (8-N-2) for RTU 1: odd parity(8-O-1)for RTU 2: even parity(8-E-1)for RTU 3: no parity(7-N-2)for RTU 4: odd parity(7-O-1)for RTU 5: even parity(7-E-1)for RTU 6: no parity(8-N-2)for ASCII 7: odd parity(8-O-1)for ASCII 8: even parity(8-E-1)for ASCII 9: no parity(7-N-2)for ASCII 10: odd parity(7-O-1)for ASCII 11: even parity(7-E-1)for ASCII 12: No parity(8-N-1) for RTU	0	○
Fb.03	Communication delay	(0.000 ~ 0.200)s	0.005s	○
Fb.04	Time for communication timed out fault	(0.1 ~ 100.0)s	0.0s	○
Fb.05	Transmission error handling	0: alarm and coast stop 1: no alarm and continue running 2: no alarm and stop according to set method (only in communication control mode) 3: no alarm and stop according to set method (in all control modes)	1	○

Function code	Name	Value range	Default value	Alteration
Fb.06	Select communication handling operations	0: respond to writing (the inverter responds to the writing commands from upstream machine) 1: no respond to writing (the inverter responds to the reading commands from upstream machine, but does not respond to the writing commands, with the aim to improve communication efficiency)	0	○
FC group: extension card interface group: reserve				
FC.00	Reserve	--	--	○
Fd group: status display parameter group				
Fd .00	Main given set frequency	(0.00 ~ + 600.00)Hz	0.00Hz	●
Fd .01	Auxiliary given set frequency	(0.00 ~ + 600.00)Hz	0.00Hz	●
Fd .02	Set frequency	(0.00 ~ + 600.00)Hz	0.00Hz	●
Fd .03	Frequency command (after acceleration or deceleration)	(0.00 ~ 600.00)Hz	0.00Hz	●
Fd .04	Given torque	(-300.0 ~ + 300.0%)(relative to the rated torque of motor)	0.0%	●
Fd .05	Output frequency	(0.00 ~ + 600.00)Hz	0.00Hz	●
Fd .06	Output voltage	(0 ~ 480)V	0V	●
Fd .07	Output current	(0.0 ~ 3000.0)A(relative to 0.0 ~ 3.0)Ie	0.0A	●
Fd .08	Running rotation speed	(0 ~ 60000)rpm	0rpm	●
Fd .09	Output torque	(-300.0 ~ + 300.0%)(relative to the rated torque of motor)	0.0%	●
Fd .10	ASR controller output	(-300.0 ~ + 300.0%)(relative to the rated torque of motor)	0.0%	●
Fd .11	Torque current	(-300.0 ~ + 300.0)%	0.0%	●
Fd .12	Magnetic flux current	(0 ~ 100.0)%	0.0%	●
Fd .13	Motor power	(0.0 ~ 200.0%)(relative to the rated power of motor)	0.0%	●
Fd .14	Estimated motor frequency	(-300.00 ~ + 300.00)Hz	0.00Hz	●
Fd .15	Measured motor frequency	(-300.00 ~ + 300.00)Hz	0.00Hz	●
Fd .16	Bus voltage	(0 ~ 800)V	0	●
Fd .17	Inverter running status	Setup range: 0x0000~0xFFFF Bit0: run/stop Bit1: reverse rotation/forward rotation Bit2: running at zero speed Bit3: accelerating Bit4: decelerating Bit5: running at constant speed Bit6: conducting pre-excitation Bit7: conducting Auto-Tuning Bit8: speed loss due to overcurrent Bit9: speed loss due to DC overvoltage Bit10: rotation speed is limited Bit11: frequency is limited Bit12: inverter fault Bit13: ready to run Bit14: reserve Bit15: undervoltage/normal	0x0000	●

Function code	Name	Value range	Default value	Alteration
Fd .18	Switch input terminal status	Setup range: 0x0000~0xFFFF 0: break; 1: make Ones: BIT0~BIT3: Di1~DI4 Tens: BIT0: HDI BIT1~BIT3: reserve	0x0000	●
Fd .19	Switch output terminal status	Setup range: 0x0000~0xFFFF 0: break; 1: make Ones: BIT0~BIT2: HDO. RO Tens: reserve	0x0000	●
Fd .20	Ai1 input voltage	(-10.00 ~ + 11.00)V	0.00V	●
Fd .21	Ai2 input voltage	(-10.00 ~ + 11.00)V	0.00V	●
Fd .22	Reserve	--	--	●
Fd .23	Ai1 percentage after regulation	(-100.00 ~ 110.00)%	0.00%	●
Fd .24	Ai2 percentage after regulation	(-100.00 ~ 110.00)%	0.00%	●
Fd .25	Reserve	--	--	●
Fd .26	AO1 output	(0.0 ~ 100.0)%(percentage relative to full range)	0.0%	●
Fd .27	Reserve	--	--	●
Fd .28	Given process closed loop	(-100.0 ~ 100.0)%(percentage relative to full range)	0x0000	●
Fd .29	Process closed loop feedback	(-100.0 ~ 100.0)%(percentage relative to full range)	0.0%	●
Fd .30	Process closed loop error	(-100.0 ~ 100.0)%(percentage relative to full range)	0.0%	●
Fd .31	Process closed loop output	(-100.0 ~ 100.0)%(percentage relative to full range)	0.0%	●
Fd .32	High speed pulse HDI frequency	(0.1 ~ 100.0)kHz	0.0 kHz	●
Fd .33	Current PLC stage	0 ~ 15	0	●
Fd .34	Heat sink temperature	(0.0 ~ 200.0)°C	0.0°C	●
Fd .35	Rectifier bridge temperature	(1~200)°C	0°C	●
Fd .36	Total power on hours	0 ~ max. 65535 hours	0	●
Fd .37	Total running hours	0 ~ max. 65535 hours	0	●
Fd .38	Total fan running hours	0 ~ max. 65535 hours	0	●
Fd .39	Rated capacity	(0 ~ 999.9)kVA(set automatically based on model)	Factory set	●
Fd .40	Rated voltage	(0 ~ 999) V (set automatically based on model)	Factory set	●
Fd .41	Rated current	(0 ~ 999.9)A(set automatically based on model)	Factory set	●
Fd .42	Product serial number	Setup range: 0x0000~0xFFFF	0x0500	●
Fd .43	Software version number	0.00 ~ 99.99	1.00	●
Fd .44	Customize version number	0 ~ 99.99	1.00	●
Fd .45	Year of source code compilation	2014 ~ 2099	2017	●
Fd .46	Date of source code compilation	101 ~ 1231	101	●
Fd .47	Set rotation speed	(0 ~ 60000)rpm	0	●
Fd .48	Current running time	(1 ~ 65535)min	0	●
Fd .49	Remaining running time	(0 ~ 65535)H	0	●
Fd .50	Power factor angle	0.1 ~ 20.0	0	●
Fd .51	VF separation target voltage	(0.0 ~ 100.0)%(motor rated voltage)	0.0%	●
Fd .52	VF separation output voltage	(0.0 ~ 100.0)%(motor rated voltage)	0.0%	●
Fd .53	Inverter GP type	0 ~ 3	0	●
Fd .54	Motor temperature	(1~200)°C	0°C	●
Fd .55	Total power consumption	0~65535 kwh	0 kwh	●

Function code	Name	Value range	Default value	Alteration
FE Protection and alarm function group				
FE.00	Select motor overload protection	0: invalid 1: valid	1	○
FE.01	Motor overload protection gain	0.20 ~ 10.00	1.00	○
FE.02	Enabling motor overload alarm	0: invalid 1: valid	0	○
FE.03	Motor overload alarm level	(20 ~ 200)%	80%	○
FE.04	Select overvoltage speed loss protection	0: invalid 1: valid 2: only valid during deceleration	0	○
FE.05	Overvoltage speed loss gain	0 ~ 100(0: prohibited)	0	○
FE.06	Overvoltage speed loss voltage	(120 ~ 150)%	120%	○
FE.07	Overcurrent speed loss gain	0 ~ 100(0: prohibited)	1	○
FE.08	Overcurrent speed loss protection current	(100 ~ 200)%	150%	○
FE.09	Select power-on grounding short circuit protection	0: invalid 1: valid	0	○
FE.13	Select instantaneous power off operation	0: invalid 1: deceleration 2: deceleration stop	0	○
FE.14	Judgement voltage for instantaneous operation pause	(80.0 ~ 100.0)%	90.0%	○
FE.15	Judgement time for recovery of instantaneous power off voltage	(0.00 ~ 100.00)s	0.50s	○
FE.16	Judgement voltage for instantaneous power-off operation	(60.0 ~ 100.0%)(standard bus voltage)	80.0%	○
FE.17	Select load loss protection	0: invalid 1: valid	0	○
FE.18	Load loss detection level	(0.0 ~ 100.0)%	10.0%	○
FE.19	Load loss detection time	(0.0 ~ 60.0)s	1.0s	○
FE.20	Overspeed detection value	(0.0 ~ 50.0%)(max. output frequency)	20.0%	○
FE.21	Overspeed detection time	(0.0 ~ 60.0)s(0.0s do not detection)	1.0s	○
FE.22	Detection value for large speed deviation	(0.0 ~ 50.0%)(max. output frequency)	20.0%	○
FE.23	Detection time for large speed deviation	(0.0 ~ 60.0)s(0.0s do not detection)	5.0s	○
FE.24	Select input phase loss detection	0: input phase loss hardware detection 1: input phase loss software detection 2: neither software nor hardware detection for input phase loss	2	⊗
FE.25	Select output phase loss detection	0: no software detection for output phase loss 1: output phase loss software detection	1	⊗
FE.26	Fault auto reset times	0 ~ 20	0	○
FE.27	Fault auto reset interval	(0.1 ~ 100.0)s	1.0s	○
FE.28	Select fault Do action during fault auto reset	0: fault lockout prohibited 1: fault lockout allowed	0	○

Function code	Name	Value range	Default value	Alteration
FE.29	Fault record 1	0: No fault No 1: Accelerated overcurrent E.OC1 2: Deceleration overcurrent E.OC2 3: Constant speed overcurrent E.OC3 4: Accelerated overvoltage E.OU1 5: Deceleration overvoltage E.OU2 6: Constant speed overvoltage E.OU3 7: reserved 8: Input phase loss E.SPI 9: Output phase loss E.SPO 10: Inverter unit protection E.FO 11: Heat sink overheating E.OH1 12: Rectifier bridge overheating E.OH2 13: Inverter overload E.OL2 14: Motor overload E.OL1 15: External fault E.EF 16: EEprom abnormal E.EEP 17: Communication abnormal E.CE 18: reserved 19: Current detection abnormal E.ItE 20: reserved 21: Reserved 22: reserved 23: reserved 24: Motor tuning abnormal E.tE 25: reserved 26: Reserved 27: Reserved 28: reserved 29: reserved 30: Reserved 31: Undervoltage E.Uv 32: reserved 33: Motor short to ground E.StG 34: Reserved 35: reserved 36: Load E.LL 37: PID feedback lost E.FbL during runtime 38: Motor over temperature E.OT 39: reserved 40: reserved 41: reserved 42: Reserved 43 to 55: Reserved 60: Overpressure fault 63: Relay action failure 64: Communication failure 65: Relay function setting error 66: Expansion board does not match	0	●
FE.30	Bus voltage upon third (last) fault	(0.00 ~ 655.35)V	0.00V	●
FE.31	Current upon third (last) fault	(0.00 ~ 655.35)A	0.00A	●
FE.32	Frequency upon third (last) fault	(0.00 ~ 655.35)Hz	0.00Hz	●
FE.33	Inverter status upon third (last) fault	0 ~ 65535	0	●
FE.34	Input terminal status upon third (last) fault	0 ~ 9999	0	●

Function code	Name	Value range	Default value	Alteration
FE.35	Output terminal status upon third (last) fault	0 ~ 9999	0	●
FE.36	Fault record 2	0 ~ 55	0	●
FE.37	Fault record 3	0 ~ 55	0	●
FE.38	Select fault protection action 1	0x0000 ~ 0x2222 Ones: motor overload E.OL1 0: coast stop 1: stop according to set method 2: continue running Tens: input phase loss E.SPI(same as ones) Hundreds: output phase loss E.SPO(same as ones) Thousands: external fault E.EF(same as ones)	0x0000	○
FE.39	Select fault protection action 2	0x0000 ~ 0x2222 Ones: abnormal communication E.CE 0: coast stop 1: stop according to set method 2: continue running Tens: reserve Hundreds: abnormal EEprom E.EEP 0: coast stop 1: stop according to set method Thousands: reserve	0x0000	○
FE.40	Select fault protection action 3	0x0000 ~ 0x2222 Ones: load loss E.LL 0: coast stop 1: deceleration stop 2: directly jump to 7% of motor rated frequency and continue running, automatically recover to set frequency if there is no phase loss Tens: PID feedback loss during operation E.FbL 0: coast stop 1: stop according to set method 2: continue running Hundreds: large speed deviation E.dEv(same as tens) Thousands: motor overspeed E.OS(same as tens)	0x0000	○
FE.41	Select fault protection action 4	0x0000 ~ 0x2222 Ones: reserve Tens: reserve Hundreds: reserve Thousands: reserve	0x0000	○
FE.42	Select fault protection action 5	0x0000 ~ 0x2222 Ones: reserve Tens: reserve Hundreds: reserve Thousands: reserve	0x0000	○
FE.43	Select frequency for continue running in case of fault	0 ~ 4 0: run with current frequency 1: run with set frequency 2: run with upper frequency limit 3: run with lower frequency limit 4: run with backup frequency in case of abnormality	0	○

Function code	Name	Value range	Default value	Alteration
FE.44	Setup backup frequency in case of abnormality	(0.0 ~ 100.0)% (correspond to max. frequency)	10.0%	○
FE.45	Overcurrent speed loss proportional gain	0 ~ 60000	1000	○
FE.46	Overcurrent speed loss integral gain	0 ~ 60000	500	○
FE.47	Overcurrent speed loss differential gain	0 ~ 60000	1000	○
FE.48	Select overvoltage speed loss mode	0: no deceleration 1: active acceleration	1	○
FE.49	Frequency of Overcurrent when OverVoltage function invalid.	0 ~ 600.00HZ	0.00HZ	○
FE.50	OverVoltage speed loss proportional gain	0 ~ 60000	300	○
FE.51	OverVoltage speed loss integral gain	0 ~ 60000	0	○
FE.52	OverVoltage speed loss differential gain	0 ~ 60000	0	○

The logo for CHINT, featuring the letters 'CHINT' in white on a blue background.

CHINT ELECTRICS

NVF5 Series
Inverters
User Instruction

Zhejiang Chint Electrics Co., Ltd.

Add: No.1, CHINT Road, CHINT Industrial Zone, North Baixiang,

Yueqing, Zhejiang 325603, P.R.China

E-mail: global-sales@chint.com

Website: <http://en.chint.com>



0ZTD.463.1141.EN

