



NJBK2 Motor Protection Relay

1. General

NJBK2 series motor protection relay (hereinafter referred to protector as simply) is applicable for overload, locked-rotor, phase-failure, three phase current unbalance, earthing and PTC temperature protection of AC motor @ A.C.50Hz, less than 690V rated insulation voltage and 1A ~ 800A rated operating current for its continuous working or discontinuous working.

This product meets the requirements of IEC 60947- 4-1.

2. Type designation

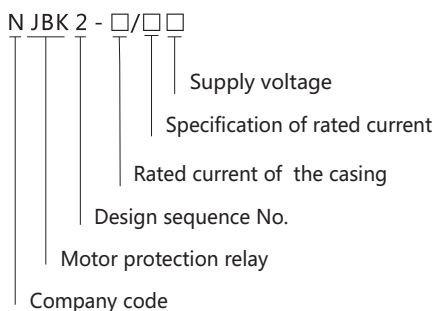

3. Operating conditions

- 3.1 Altitude $\leq 2000\text{m}$.
- 3.2 Ambient air temperature $-5^{\circ}\text{C} \sim +40^{\circ}\text{C}$, with daily average $\leq +35^{\circ}\text{C}$.
- 3.3 Atmospheric condition: when the highest temperature is $+40^{\circ}\text{C}$, relative humidity of air shall be no more than 50%, higher relative humidity shall be allowable at lower temperature.
The max monthly average relative humidity of the most humid month shall be not more than 90% and the lowest monthly average temperature of the same month should be no more than $+25^{\circ}\text{C}$, condensed dew on surface of the product due to the change of the temperature should be taken into account.
- 3.4 Pollution Level: Level 3.
- 3.5 Installation Category: III.
- 3.6 Inclination between installation plane and vertical plane shall $\leq \pm 5^{\circ}$.
- 3.7 At places without prominence rock, impact and vibration.
- 3.8 At places without explosive risk, without gases that may be corrosive to metal or gases that may cause damage to the insulation, and with little conducting dust
- 3.9 At places where rain & snow proof facilities are equipped with and not being full of steam.

4. Technical data

- 4.1 Main circuit: rated insulation voltage AC690V, rated frequency 50Hz.

Type	Rated current (A)	Setting current range (A)	Suitable motor power (kW)
NJBK2-200/10	10	2~10	1~5
NJBK2-200/50	50	10~50	5~25
NJBK2-200/200	200	40~200	20~100
NJBK2-400/400	400	160~400	80~200
NJBK2-800/800	800	320~800	160~400

- 4.2 Auxiliary circuit: rated insulation voltage AC380V, rated frequency 50Hz, Utility classes, rated operating voltage, rated operating current and conventional heating current.

Utility classes	AC-15	
Rated operating voltage (V)	240	380
Rated operating current (A)	1.5	0.95
Conventional heating current (A)	5	

5. Design features

- 5.1 Equipped with functions of overload, locked-rotor, phase-failure, three-phase unbalance, earthing and PTC temperature protection etc.
- 5.2 Six indicators indicate status of power supply, operation, phase-failure (three phase unbalance), overload, earthing and temperature, respectively. Equipped with function of fault memory.
- 5.3 Four kinds of trip class.
- 5.4 Digital dial-up settings with high precision.
- 5.5 Three kinds of reset modes: manual reset, remote manual reset and automatic reset.



5.6 Installation mode: installation in parts and integral installation. Transformer Installation: bolts installation and Track installation. Relay Installation: Rapid Track installation through meter.

5.7 Equipped with function of six times of current to test [Test by 6 times of the current].

6. Protection characteristics

6.1 Operation characteristics under three-phase balanced-load status

S.N.	Times of setting current	Trip class	Operation time	Test condition	Ambient temperature°C
1	1.05	10A	<2h non-tripping	Start from cold status	
		10			
		20			
		30			
2	1.2	10A	<2h tripping	Start right after Item No.1	20±2
		10			
		20			
		30			
3	1.5	10A	<2min	Start right after Item No.1	
		10	<4min		
		20	<8min		
		30	<12min		
4	7.2	10A	2s < tp ≤ 10s	Start from cold status	
		10	4s < tp ≤ 10s		
		20	6s < tp ≤ 20s		
		30	9s < tp ≤ 30s		

6.2 Operation characteristic under phase-failure status

S.N.	Times of setting current		Operation time	Test condition	Ambient temperature°C
	Any two phases	The third phase			
1	1.0	0.9	<2h non-tripping	Start from cold status	20±2
2	0.3~1.0	<Imax×40%	≤5s		
3	0.3~1.0	0	≤5s		

6.3 Tripping feature

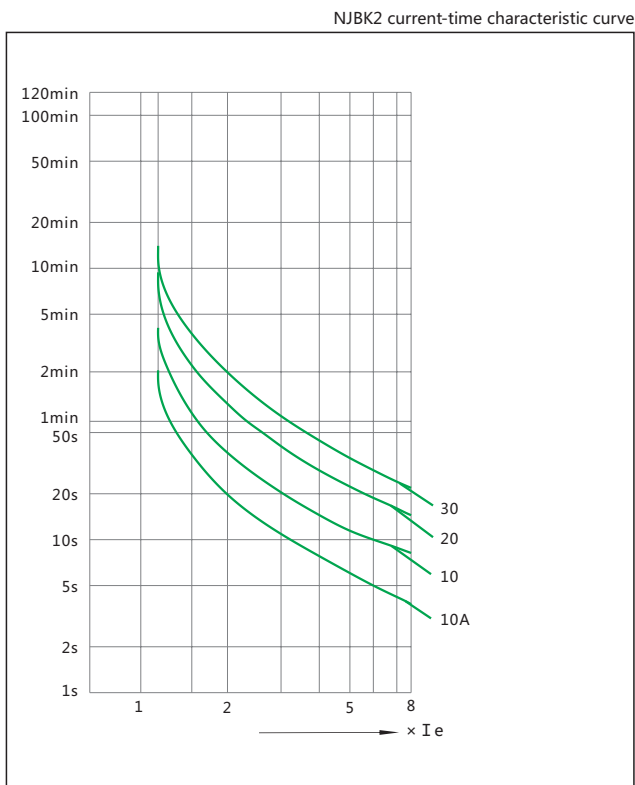

6.4 Performance feature of earthing protection

Serial number	Zero sequence current (A)	Operation time (s)
1	0.5	≤1
2	1	≤1

6.5 Protection feature of pre-buried PTC thermistor in motor:

PTC thermistor protection is carried out by detecting resistance value of thermistor output from PTC detector pre-buried in stator winding or bearing of motor and taking it as protection condition to judge whether motor is overheating, when PTC reaching reacting resistance value, reacting delay <1s.

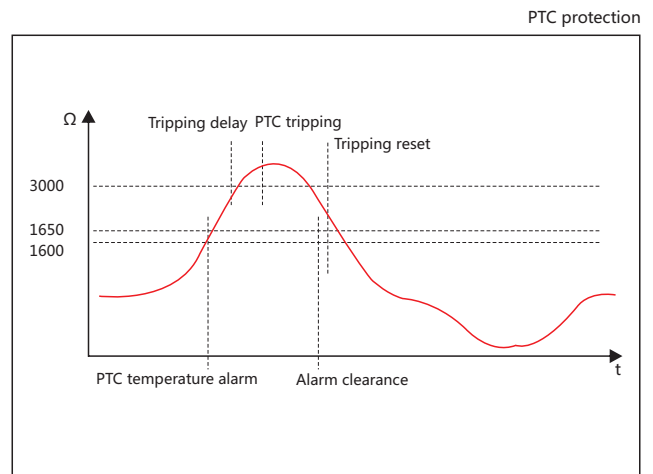

6.6 Reset feature: Manual reset, automatic reset and remote manual reset are available for option. Resetting time varies according to different trip class, among the range of 4min to 12min.

7. Wiring diagram

7.1 Wiring diagram for control power supply @ AC220V voltage

Wiring diagram for control power supply @ AC220V voltage

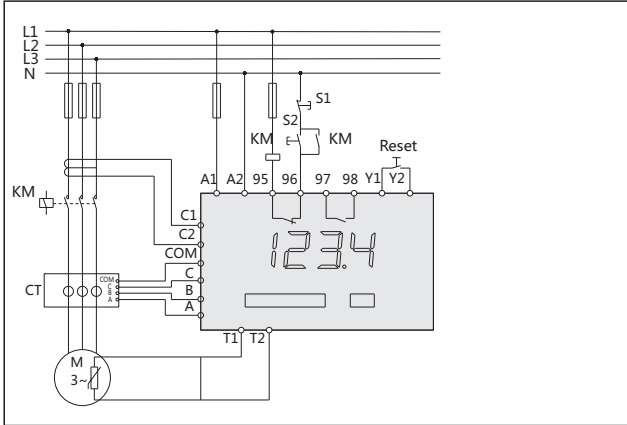

7.2 Wiring diagram for control power supply @ AC380V voltage

Wiring diagram for control power supply @ AC380V voltage

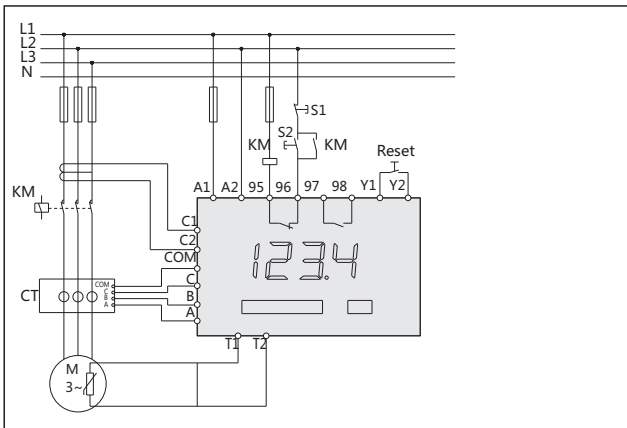

8. Accessory instruction

S.N.	Designation	Quantity	Remarks
1	NJBK2-200 conductive bar	3	It is suggested to be used when main circuit current is within the range of 80A-200A.
2	NJBK2 wire holder	2	Instrument installation
3	NJBK2 clamp	1	Instrument installation

9. Overall and mounting dimensions (mm)

9.1 Overall and Amounting dimensions of NJBK2-200 transformer

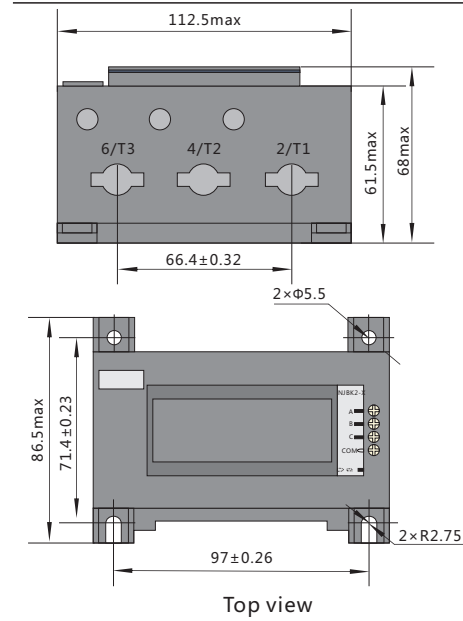

9.2 Overall and mounting dimensions of NJBK2-200 macropore transformer

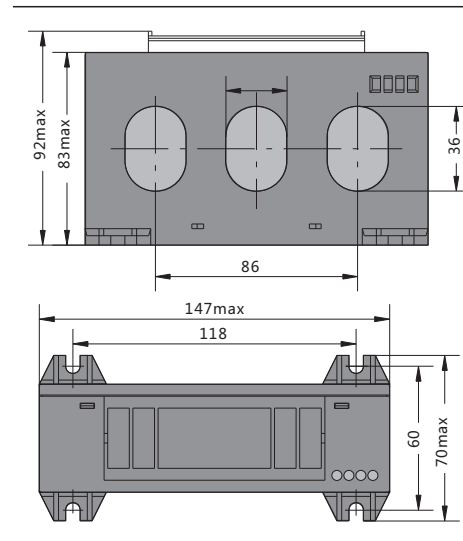

9.3 Overall and Mounting dimensions of NJBK2-400 transformer

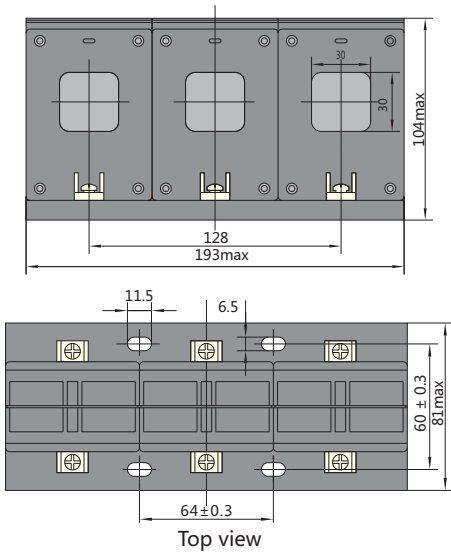

9.4 Overall and mounting dimensions of NJBK2-800 transformer

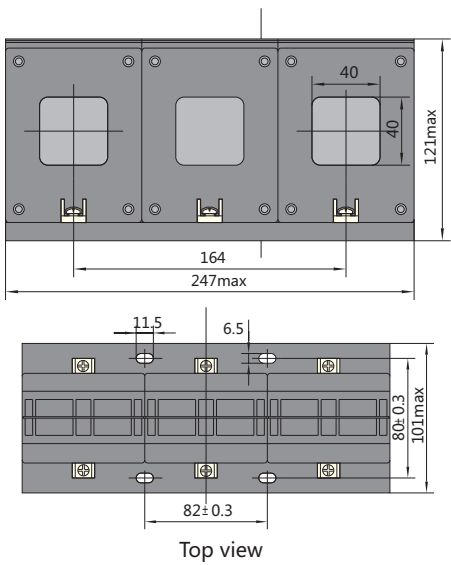

9.5 Overall and mounting dimensions of module sample

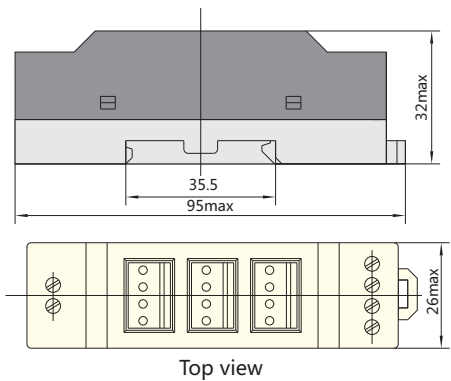

9.6 Overall and mounting dimensions of relay of protector

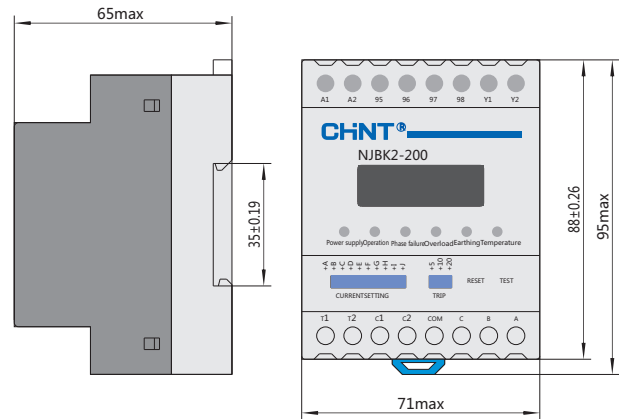

9.7 Overall and mounting dimensions of relay of protector

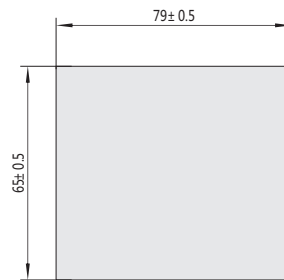

10. Ordering information

10.1 Designation and specification of protector, select control current and voltage (AC220V, AC380V), setting current range (2A~10A, 10A~50A, 40A~200A, 160A~400A, 320A~800A), accessories (NJBK2-200 conductive bar, NJBK2 wire holder, NJBK2 clamp) according to operating requirements.

10.2 Order Quantity.