

NC2 Series
AC Contactor

User Instruction

Safety Warning

- 1 Only professional technicians are allowed for installation and maintenance.
- 2 Installation in any damp, condensed-phase environment with inflammable and explosive gas is forbidden.
- 3 When the product is being installed or maintained, the power must be switched off.
- 4 You are prohibited from touching the conductive part when the product is operating.

1 Use Purpose and Application Range

NC2 series AC contactor is mainly used in AC 50Hz (or 60Hz) circuits with rated operating voltage up to 690V and rated operating current from 115A~800A under AC-3 application category. It is used to connect and disconnect circuits remotely, and can be used with proper thermal overload relay to act as electromagnetic starter so as to protect circuits from possible overload.

2 Key Technical Parameters and Performance

Table 1 Environmental conditions

Environmental Conditions	
Ambient temp. (°C)	-5°C~+40°C, average temperature should not exceed +35°C within 24h
Hot and humid atmospheric conditions	Relative humidity should not exceed 50% at +40°C; up to 90% at +20°C;
Altitude	No influence below 2000m,
Pollution class/installation category	Class 3/III

Table 2 Key technical parameters and performance index

Model		NC2-115	NC2-150	NC2-185	NC2-225	NC2-265	NC2-330	
Rated operating current Ie(A)	380V/400V	AC-3	115	150	185	225	265	330
		AC-4						
	660V/690V	AC-3	86	108	118	137	170	235
		AC-4						
Conventional free air thermal current Ith (A)		200		275		315	380	
Rated insulation voltage (V)		1000						
Rated impulse withstand voltage (kV)		8						
Power of controllable 3-phase motor (kW)	380/400V	55	75	90	110	132	160	
	660/690V	80	100	110	129	160	220	
Electrical life (x10 ⁴ times) (400V)	AC-3	120		100		80		
	AC-4	2		1				
Mechanical life (x10 ⁴ times)		1000			600			
Fuse rated current (A)		200	225	315		355	450	
Coil power	Pick-up (VA)	660		966		840	1500	
	Hold (VA)	85.5		91.2		150	34.2	
Rated control power supply voltage Us (V)		AC: 110V, 127V, 220V, 380V, DC: 48V, 110V, 220V				AC: 110V, 127V, 220V, 380V, DC: 110V, 220V		
Operating range		Pick-up voltage: (85%~110%)Us, Release voltage: NC2-115~265: (20%~75%)Us, NC2-330~800: (10%~70%)Us						
Auxiliary contacts	Basic parameters	AC-15: 360VA; DC-13: 33W; Ith: 10A						
	Top mounting combination	F4-20, F4-11, F4-02, F4-40, F4-31, F4-22, F4-13, F4-04, F5-T0, F5-T2, F5-T4, F5-D0, F5-D2, F5-D4						

Table 2 (continue)

Model			NC2-400	NC2-500	NC2-630	NC2-800	
Rated operating current Ie(A)	380V/ 400V	AC-3	400	500	630	800	
		AC-4				630	
	660V/ 690V	AC-3	303	353	462	486	
		AC-4				462	
Conventional free air thermal current Ith (A)			450	630	800	800	
Rated insulation voltage Ui (V)			1000				
Power of controllable 3-phase motor (kW)	380/400V		200	250	335	450 (AC-3)	335 (AC-4)
	660/690V		280	335	450	475 (AC-3)	450 (AC-4)
Electrical life (x10 ⁴ times) (400V)	AC-3		80			60	
	AC-4		1	0.6			
Mechanical life (x10 ⁴ times)			600			300	
Rated current of RT16 (36) fuse			560	750	950	1000	
Coil power	50Hz	Pick-up (VA)	1500			1700	
		Hold (VA)	34.2			34.2	
Energy efficiency class			2				
Operating range			Pick-up voltage: (85%~110)%Us, Release voltage: NC2-115~265: (20%~75%)Us, NC2-330~800: (10%~70%)Us				
Auxiliary contacts	Basic parameters		AC-15: 360VA; DC-13: 33W; Ith: 10A				
	Top mounting combination		F4-20, F4-11, F4-02, F4-40, F4-31, F4-22, F4-13, F4-04, F5-T0, F5-T2, F5-T4, F5-D0, F5-D2, F5-D4				

3 Installation

See the Figure 1 and Figure 2 below for accessory installation and contactor schematic diagram.

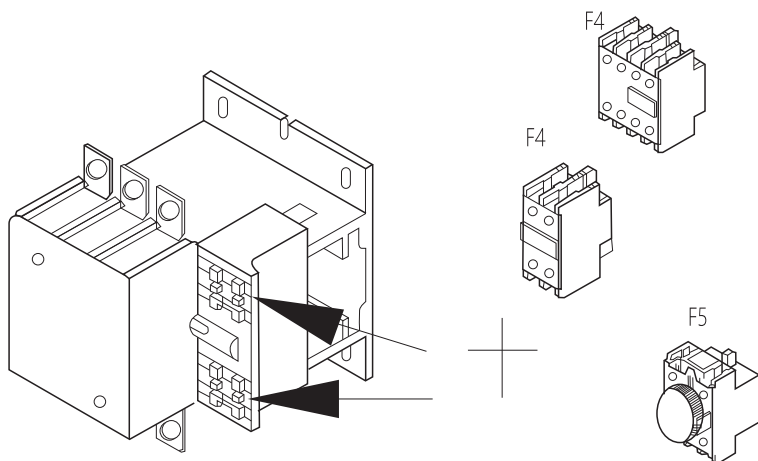

Figure 1 Installation conditions

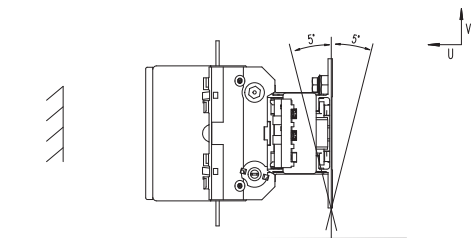
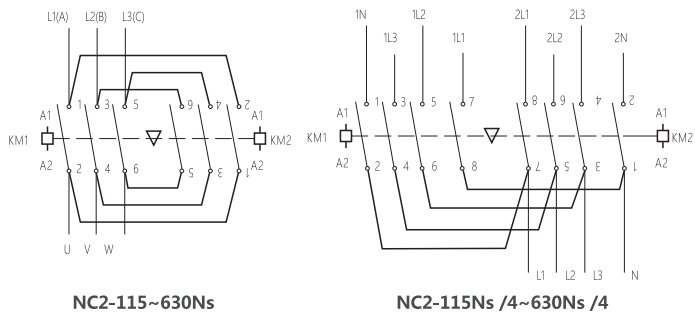

Figure 2 Installation conditions

Outline and installation dimensions:

See Figure 3 and Table 3 for the outline and installation dimensions of NC2-115~800 series AC contactors.

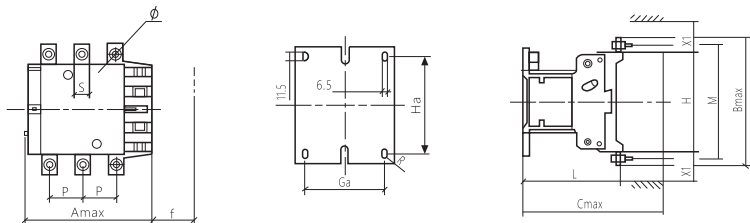
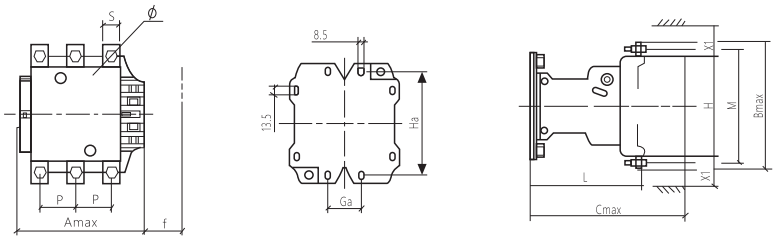
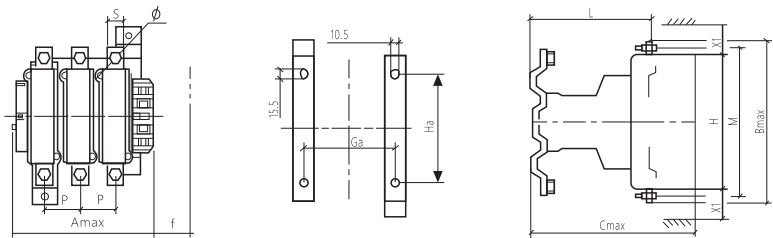

Figure 3.1 Outline and installation dimensions of NC2-115~330 AC contactors

Figure 3.2 Outline and installation dimensions of NC2-400~500 AC contactors

Figure 3.3 Outline and installation dimensions of NC2-630~800 AC contactors
Table 3 Outline and installation dimensions of NC2-115~800

(mm)

Dimension code	NC2-115		NC2-150		NC2-185		NC2-225		NC2-265	
	3P	4P	3P	4P	3P	4P	3P	4P	3P	4P
A	168	204	168	204	171	211	171	211	202	247
B	163	163	171	171	175	175	198	198	204	204
C	172	172	172	172	183	183	183	183	215	215
P	37	37	40	40	40	40	48	48	48	48
S	20	20	20	20	20	20	25	25	25	25
Φ	M6	M6	M8	M8	M8	M8	M10	M10	M10	M10
f ¹⁾	131	131	131	131	131	131	131	131	147	147
M	147	147	150	150	154	154	172	172	178	178
H	124	124	124	124	127	127	127	127	147	147
L	107	107	107	107	113.5	113.5	113.5	113.5	141	141
X1 ²⁾										
200~500V	10		10		10		10		10	
660~1000V	15		15		15		15		15	
Ga	80								96	
Ha	110-120									

Dimension code	NC2-330		NC2-400		NC2-500		NC2-630		NC2-800	
	3P	4P	3P	4P	3P	3P	4P	3P		
A	215	261	215	261	235	312	389	312		
B	208	208	208	208	238	305	305	305		
C	220	220	220	220	233	256	256	256		
P	48	48	48	48	55	80	80	80		
S	25	25	25	25	30	40	40	40		
Φ	M10	M10	M10	M10	M10	M12	M12	M12		
f ¹⁾	147	147	147	147	150	181	181	181		
M	181	181	181	181	208	264	264	264		
H	158	158	158	158	172	202	202	202		
L	145	145	145	145	146	155	155	155		
X1 ²⁾										
200~500V	10		15		20					
660~1000V	15		20		30					
Ga	96		80		180		240	180		
Ha	110-120		170-180		180-190					

Note: f: Take the minimum distance required between each coil;
X1: Determine flashover distance according to operating voltage and breaking capacity.

See Figure 4 and Table 4 for the outline and installation dimensions of NC2-115Ns~630Ns series contactors.

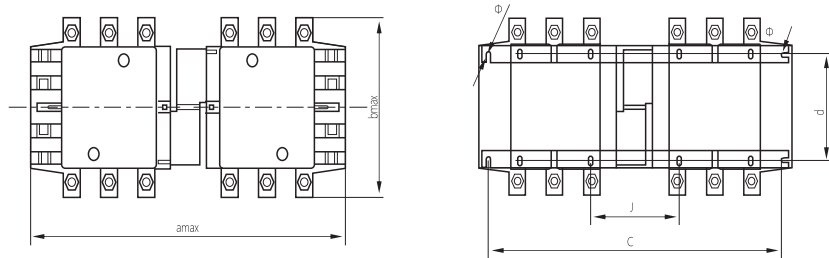

Figure 4 Outline and installation dimensions of NC2-115Ns~800Ns AC contactors

Table 4 Outline and installation dimensions of NC2-115Ns~800Ns

(mm)

Model	Pole	Amax	Bmax	C	D	J	Φ
NC2-115Ns	3	350	163	330	110-120	71	6.5
	4	425	208	370		108	
NC2-150Ns	3	350	171	330		71	
	4	425	211	370		111	
NC2-185Ns	3	350	174	330		78	
	4	430	223	370		118	
NC2-225Ns	3	350	197	330		78	
	4	430	243	370		118	
NC2-265Ns	3	450	203	428		109	
	4	546	249	485		157	
NC2-330Ns	3	450	206	428		124	
	4	546	251	485		172	
NC2-400Ns	3	485	206	460	157		
	4	595	251	485	157		
NC2-500Ns	3	485	238	460	156		
	3	650	304	625	139		
NC2-630Ns	4	810	364	785	139		
	3	650	304	625	139		
NC2-800Ns	3	650	304	625	139	10.5	

Note: Dimension bmax includes external connecting board;

Dimension cis the installation dimension of the mechanical interlock product assembled by manufacturer.

See Figure 5 and Table 5 for the outline and installation dimensions of NC2-115Nc~800Nc AC contactors.

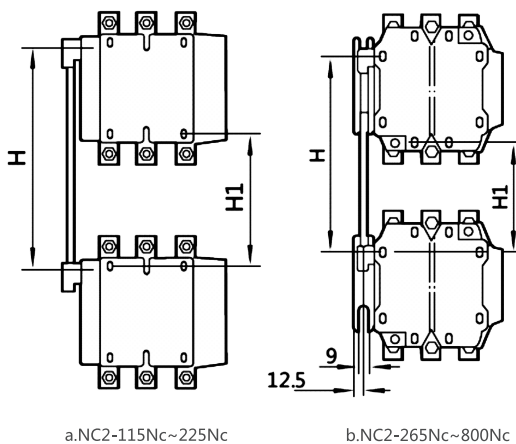

a.NC2-115Nc~225Nc

b.NC2-265Nc~800Nc

Figure 5 Outline and installation drawing of NC2-115Nc~800Nc

Table 5 Outline and installation dimensions of NC2-115Nc~800Nc

(mm)

Model	H		H1	
	Min	Max	Min	Max
NC2-115Nc NC2-150Nc	200	310	80	190
NC2-185Nc NC2-225Nc	220	310	100	190
NC2-265Nc	250	380	130	260
NC2-330Nc	260	380	60	200
NC2-400Nc	280	380	100	200
NC2-500Nc	300	380	120	200
NC2-630Nc~800Nc	380	380	200	200

Note: H is the center-to-center distance of mechanical interlock shaft. (Namely the center-to-center distance of two contactors)

Installation drawing of interlock product:

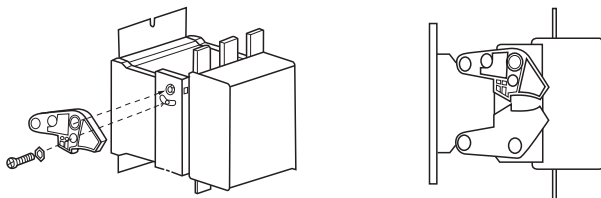
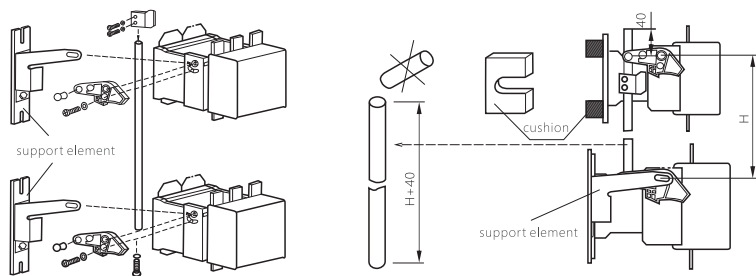
Figure 6 Horizontal mechanical interlock

Figure 7 Vertical mechanical interlock















Note: 1. For vertical installation, please install the product with smaller current on the top; after finishing installation, if length of the connecting bar reaches $H+40$, user can cut off the extra part on the top (See Figure 7);

2. If the vertically installed interlock product is made up of NC2-115~225, NC2-265~800 and the mechanical interlock mechanism, please add a cushion block under NC2-115~225 (See Figure 7);

3. If the vertically installed interlock product is made up of NC2-225~800 and the mechanical interlock mechanism, please add a supporting element (See Figure above).

4 Maintenance

Wiring capacity of terminals:

Main circuit	 M6~M10 (3~10)N•m		NC2-115~225	S (mm ²)						 With prefabricated terminal
	—	—		—	—	10~150	—			
Control circuit	 M10~M12 (10~14)N•m		NC2-265~800	S (mm ²)						—
	—	—		—	—	50~240	—			
Control circuit	 M3.5 0.8N•m	Slot type Philips 	NC2-115~800							 A > 3.5mm, L < 8mm
				mm ²	mm ²	mm ²	mm ²	mm ²	mm ²	
				1~4	1~4	1~4	1~2.5	1~4	1~4	

Check if the contactor can operate reliably every month. Method: Check if the contact incline 5° forward upon pick-up and incline 5° backward upon release.

Conduct maintenance every month.

Note: Do not disassemble, assemble and repair the product at will. Replace the product if it is found to be damaged.

Table 6 Analysis and Troubleshooting of Faults

Symptoms	Cause analysis	Troubleshooting method
The product does not operate or does not operate reliably	Inconsistency between control power voltage and coil voltage.	Use control power supply that complies with coil voltage.
	Insufficient operation circuit power capacity or disconnection or wrong connection exists in the circuit.	Check the circuit to ensure correct connection.
	Coil burnt; mechanical movable parts jammed.	Replace the coil, remove foreign objects or replace the product.
Noise	There are foreign objects on the polar face of magnet yoke or armature.	Clean the polar face of the iron core.
	The voltage of control power supply is too low.	Use control power supply that complies with coil voltage.
The product does not release or release slowly	Contact welding	Replace the product.
	There is oil or dust on the polar face of the iron core.	Clean the polar face of the iron core.

5 Environmental Protection

In order to protect the environment, the product or product parts should be disposed of according to the industrial waste treatment process, or be sent to the recycling station for assortment, dismantling and recycling according to local regulations.

CHNT

QC PASS

NC2 Series
AC Contactor
IEC/EN 60947-4-1

Check 03

Test date: Please see the packing

ZHEJIANG CHINT ELECTRICS CO., LTD.

CHINT

CHINT ELECTRICS

NC2 Series
AC Contactor
User Instruction

Zhejiang Chint Electrics Co., Ltd.

Add: No.1, CHINT Road, CHINT Industrial Zone, North Baixiang,

Yueqing, Zhejiang 325603, P.R.China

E-mail: global-sales@chint.com

Website: <http://en.chint.com>

