

Figure 64. Setting the ground alarm current value threshold

(3) Query status: The query status may be entered by pressing the "Query" button in the default interface. In the query status, the recent 10 fault records, recent 8 alarm records, the number of circuit breaker operations, life records and heat capacity information may be queried. For examples, see Figure 65, Figure 66, Figure 67 and Figure 68.

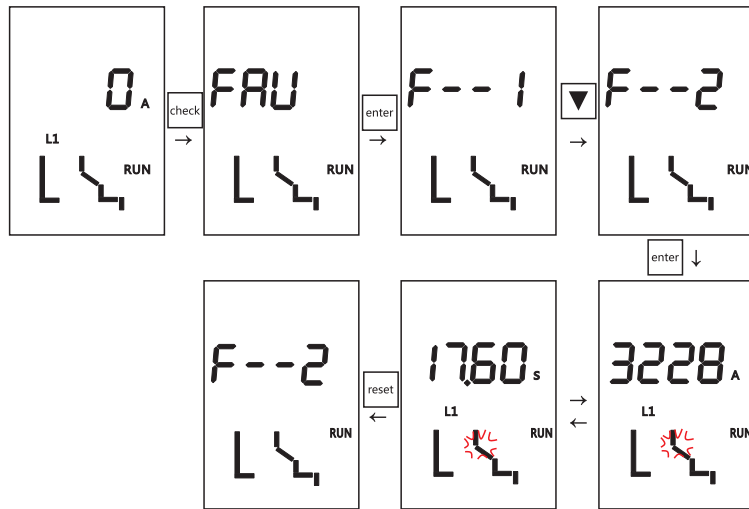

Figure 65. Querying the second fault record

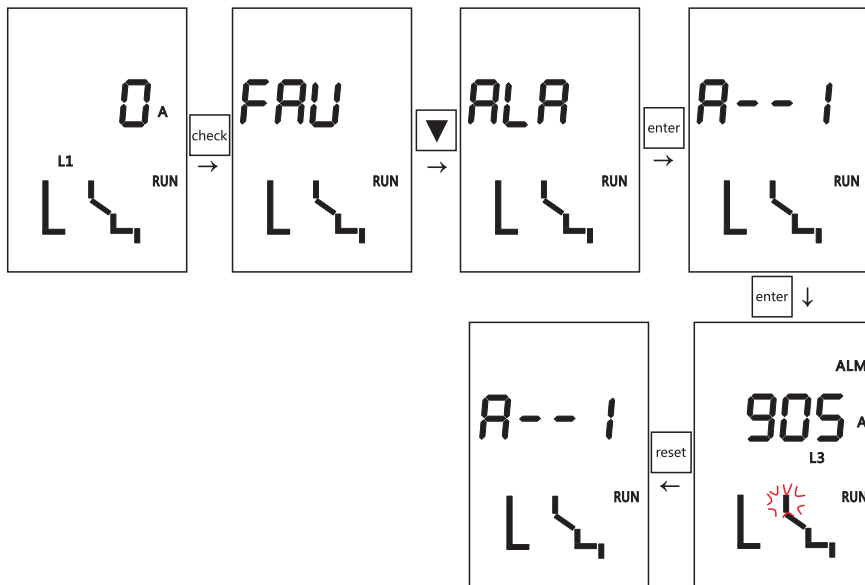

Figure 66. Querying the first alarm record

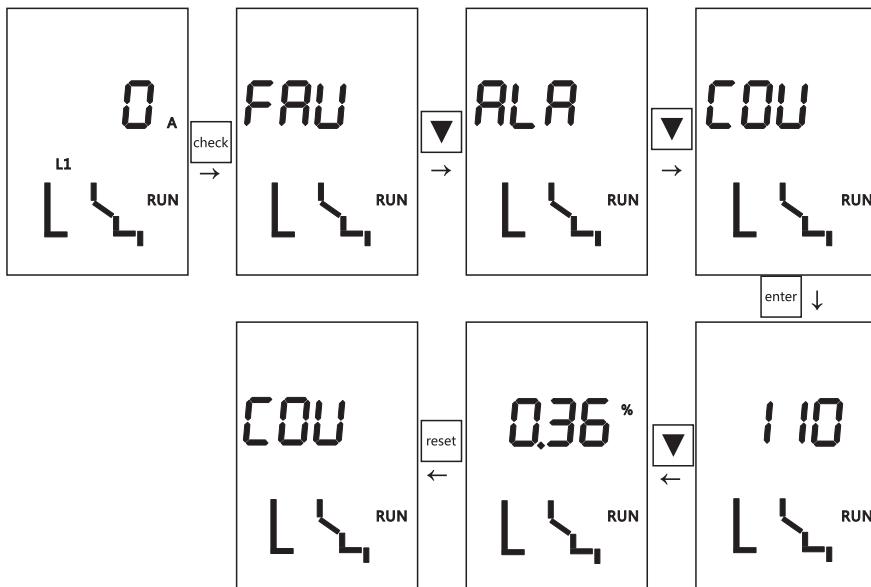

Figure 67. Querying the number of operations and the life of the circuit breaker

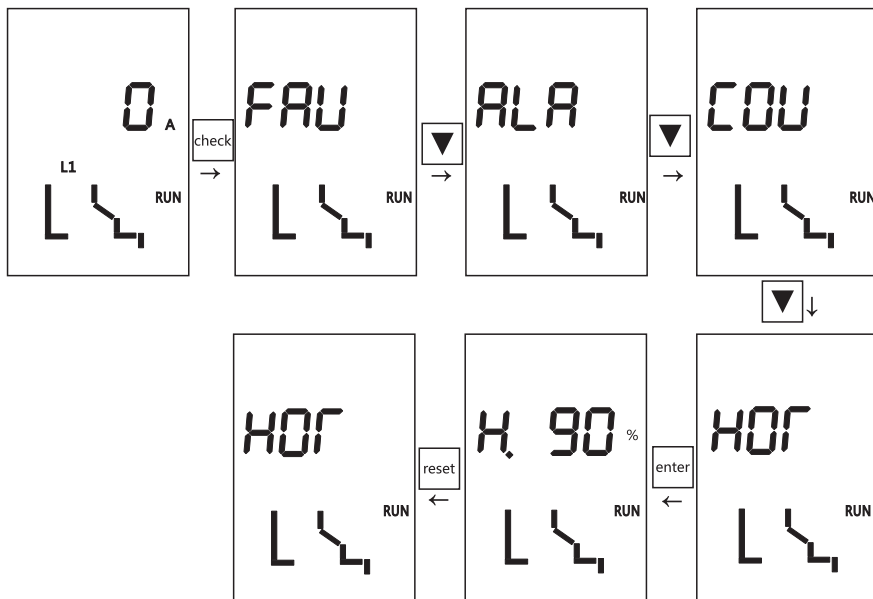

Figure 68. Querying the thermal capacity when the circuit breaker is released due to faults

(4) Release status: In addition to the statuses above that may be set and queried, the fault release status of the circuit breaker is illustrated in Figure 69 and Figure 70.

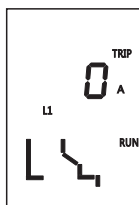
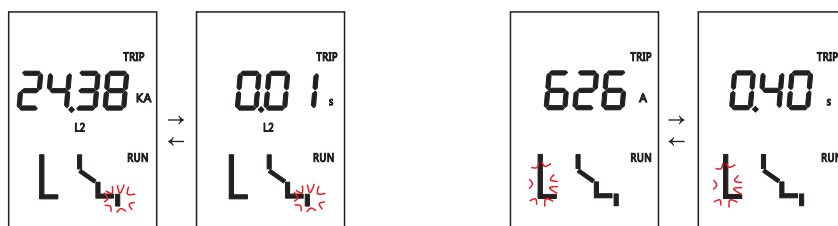

Figure 69. Pressing "Test" to simulate the instantaneous release status



70-a Instantaneous fault release status

70-b Grounding fault release status

Figure 70. Pressing "Test" to eliminate the fault in case of a release fault

### 12.1.6 Default Interface and Menu Structure of 3M/3H Controller

The 3M/3H controller provides four theme menus and one default interface. The theme menus are the measurement menu, the parameter setting menu, the protection parameter setting menu, and the history record and maintenance menu.

Note: For detailed operation of the 3M/3H controller, see the NA1 multi-function intelligent controller manual.

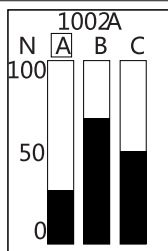

Figure 71. Default Interface of 3M/3H Controller

### 12.2 Shunt release

The power-on time cannot be greater than 2 seconds / time, and the power-on frequency cannot be greater than 5 times / minute.

- a. The shunt release should be used except for special products where the circuit breaker must be directly disconnected manually;
- b. The shunt release could operated within 10 meters to break the circuit breaker.

Table 21 Characteristics of shunt release

Rated control power supply voltage Us(V)		AC220/230	AC380/400	DC220	pulse	AC110 ( not available for NA1-1000X )	
Operating voltage (V)		(0.7-1.1)Us					
Break time (ms)		≤28					
Power consumption (VA/W)	Inm=1000A	pulse	56	56	250	250	-
	Inm=2000A~6300A	Intermittent(default)	300	300	132	70	300
		Pulse(option)	880	1800	880	850	850

- Notes: 1. It must select pulse type in the automatic control system.  
 2. power-on time of the intermittent type cannot be greater than 2 s, pulse frequency of the pulse type cannot be more than 5 times/min, or the components are easily burnt;  
 3. If the circuit breaker is not break by a single power-on of 15 s, must disconnect the power on the shunt release immediately.



Figure 72.shunt release

12.3 Closed Electromagnet

After the energy storage of the motor is completed, the closed electromagnet can be operated and controlled within a range of 10 meters to instantaneously release the energy storage spring force of the operating mechanism to close the circuit breaker.

Table 22 Characteristics of closed electromagnet

Rated control power supply voltage Us(V)			AC220/230	AC380/400	DC220	DC110	AC110 ( not available for NA1-1000X )
Operating voltage (V)			(0.85-1.1)Us				
Close time (ms)			≤50				
Power consumption (VA/W)	Inm=1000A	pulse	56	56	250	250	-
	Inm=2000A~6300A	Intermittent(default)	300	300	132	70	300
		Pulse(option)	880	1800	880	850	850

- Notes: 1. It must select pulse type in the automatic control system.  
 2. power-on time of the intermittent type cannot be greater than 2 s, pulse frequency of the pulse type cannot be more than 5 times/min, or the components are easily burnt;  
 3. Ensure that the product is in the energy storage state so that the closed electromagnet may be energized;  
 4. If the product is not closed after a single power-on for 15s, must disconnect the power on the closed electromagnet immediately.



Figure 73.closed electromagnet

12.4 Undervoltage release (UVT) (Default, The power must be turned on before the circuit breaker is closed)

12.4.1 The undervoltage release has instantaneous operation and delayed operation:

**Table 23 Operation types of each frame under voltage release**

	Self-priming	Helped priming
Undervoltage instantaneous release	Inm=1000A, 6300A	Inm=2000A, 3200A, 4000A/3
Undervoltage delay release	Inm=1000A, 6300A	Inm=2000A, 3200A, 4000A/3

**Notes:** 1. Inm=1000A undervoltage delay does not require an external delay controller. The power-off operation is an instantaneous operation. There is no zero voltage delay function;  
 2. Inm=6300A undervoltage delay does not require an external undervoltage delay controller. There is a delay function for low voltage and power off;  
 3. Inm=2000A~4000A/3 undervoltage delay requires an external delay controller. There is a delay operation when the power is off. There is a zero voltage delay function.

**Table 24 Delay time of under voltage release**

	Delay time (optional)	Accuracy
Inm=1000A	1 s, 3 s, 5 s, 7 s (not adjustable)	±15%
Inm=2000A~4000A/3	1 s, 3 s, 5 s (non-adjustable)	0~1s
Inm=6300A	0.3 s~7.5 s (adjustable)	±15%
The undervoltage will not operate when the voltage returns to 85% Ue and higher,, within 1/2 delay time.		

**Note:** A self-priming undervoltage delay release may be provided for special orders of NA1-2000X~6300X. There is no external undervoltage delay controller, and the delay time is 0.3s~7.5s, selectable and adjustable with an accuracy of ±15%.

12.4.2 When the undervoltage release is not powered, the circuit breaker cannot be closed either electrically or manually.

**Table 25 Characteristics of under voltage release**

Rated control power supply voltage Ue(V)	AC110, AC220/230, AC380/400
Operating voltage (V)	(0.35~0.7)Ue
Reliable closing voltage (V)	(0.85~1.1)Ue
Reliable not-closing voltage (V)	≤0.35Ue
Power consumption (Inm=1600A/Inm=2000A~6300A)	20VA/48VA (W)

**Figure 74. under voltage release**

**12.5 The electric energy storage mechanism** (the power-on time cannot be greater than 5 seconds / time, and the power-on frequency cannot be greater than 3 times/min) has an automatic re-energy storage function to facilitate dual power switching.

**Table 26 Characteristics of electric energy storage mechanism**

Rated control power supply voltage Us(V)	AC380/400,AC220/230	DC220, DC110
Operating voltage (V)	(0.85-1.1)Us	(0.85-1.1)Us
Power consumption (Inm=1000A)	90W	90W
Power consumption (Inm=2000A)	85W	85W
Power consumption (Inm=3200A, 4000A/3)	110W	110W
Power consumption (Inm=6300A)	150W	150W
Energy storage time	≤5s	≤5s

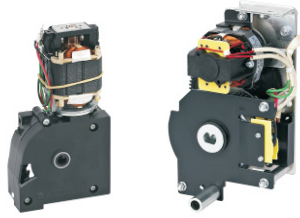

Figure 75.Motor

**12.6 Auxiliary Contacts**

Standard type: Provides users with 4 sets of conversion contacts (default configuration).

Special type: 6 sets of  $I_{nm}=1000A$  conversion contacts (for AC only);

**Table 27 Auxiliary contact capacity**

Type	NA1-1000X			NA1-2000X/NA1-2000XN/NA1-2000XH/NA1-3200X/NA1-3200XN/NA1-4000X/NA1-6300X/NA1-6300XN		
	AC230	AC400	DC220	AC230	AC400	DC220
conventional free-air thermal current I <sub>th</sub> (A)	10	6	0.5	6	6	6
Rated control capacity	300VA	100VA	60W	300VA	300VA	60W

NA1-1000X			NA1-2000X/NA1-2000XN/NA1-2000XH/NA1-3200X/NA1-3200XN/NA1-4000X/NA1-6300X/NA1-6300XN		
Category	Voltage	Current	Category	Voltage	Current
AC-15	AC230V	1.3A	AC-15	AC230V	1.3A
	AC400V	0.25A		AC400V	0.75A
DC-13	DC110V	0.55A	DC-13	DC110V	0.55A
	DC220V	0.27A		DC220V	0.27A



Figure 76.Auxiliary contact

**12.7 Door frame and pad (fixed and drawer type)**

The door frame and pad are installed on the door of the power distribution cabinet for sealing, and the protection level reaches IP40.

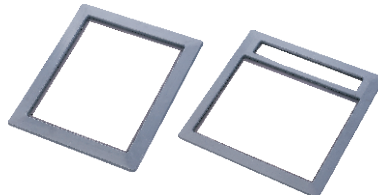
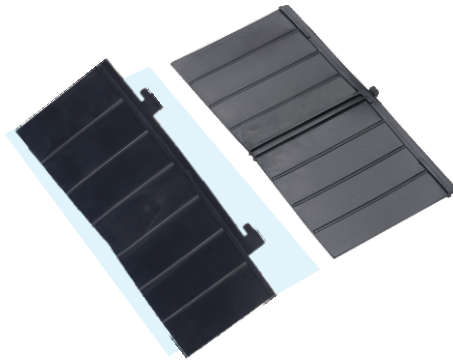

Figure 77.Door frame and pad

**12.8 Inter phased partition**

Inter phased partition are installed between the terminal blocks to increase the phase insulation of the circuit breaker.

**Note:** 1. inter phased partition used in the fixed and drawer type products are different;  
 2. Three-pole products use two inter phased partitions, and four-pole products use three inter phased partitions.  
 3. Inter phased partition in NA1-2000X-6300X, is different from that in NA1-1000X.



**Figure 78.**Inter phased partition

### 12.9 Off Position Locking Device

When the drawer type circuit breaker is in the "Disconnected" position, the lock lever can be pulled out and locked with the padlock. The circuit breaker cannot be shaken to the "Test" or "Connected" position (User purchase padlock).



**Figure 79.**Off Position Locking Device

### 12.10 Key Lock

12.10.1 The separation button of the circuit breaker can be locked in the pressed position. At this time, the circuit breaker cannot perform the making operation.

12.10.2 After the user has selected the product, the factory provides the lock and key.

12.10.3 The user purchases the key lock separately. When installing, it is recommended that the panel be opened with a hole opener. The hole opener has a diameter of  $\Phi 28\text{mm}$  for NA1-2000X-6300X and  $\Phi 21\text{mm}$  for NA1-1000X. The hole opener is provided by the user.

**Note:** After the circuit breaker is locked with the key lock, the circuit breaker cannot be closed either manually or electrically. To remove the key, press the breaking button, turn the key counterclockwise, and then pull out the key.

Circuit diagram      Possible mode of operation

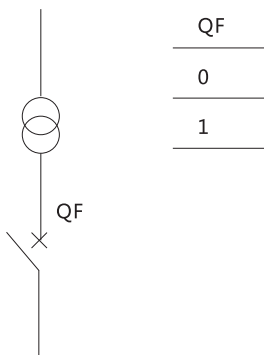

80-a One lock and one key: One circuit breaker is equipped with one separate lock and one key

Circuit diagram      Possible mode of operation

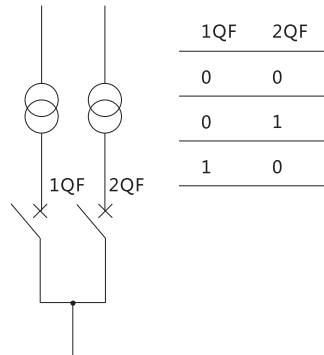

80-b Two locks and one key: Two circuit breakers are equipped with two identical locks and one key



Circuit diagram

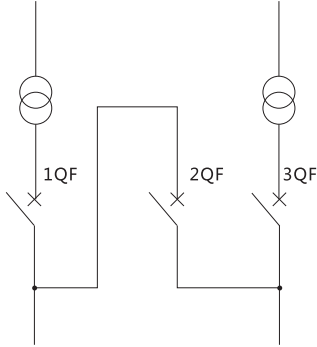

Possible mode of operation

1QF	2QF	3QF
0	0	0
0	0	1
0	1	1
1	0	0
1	1	0
1	0	1

80-c Three locks and two keys: Three circuit breakers are equipped with three identical locks and two identical keys

Circuit diagram

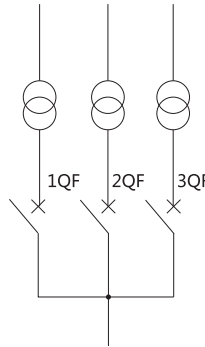

Possible mode of operation

1QF	2QF	3QF
0	0	0
0	0	1
0	1	0
1	0	0

80-d Three locks and one key: Three circuit breakers are equipped with three identical locks and one key

Figure 80.Operation mode of circuit breaker equipped with locks and keys



Figure 81.Key Lock

★ NA1Install the locking system

1. Components of the locking system:



2. Installation sequence:

1. Boring here, and polish the hole make it smooth
2. Put the washer into the hole
3. Install the lock here
4. Push the red button "ON", and take the key out, then install the cover.

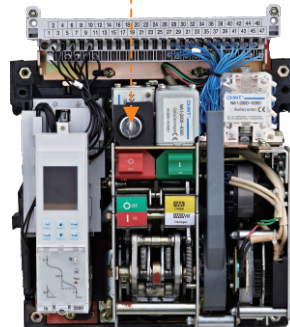
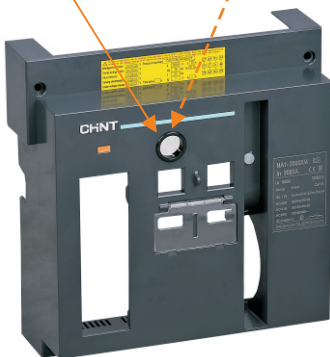

Figure 82.NA1 instal the locking system

12.11 Transparent protective cover

(only available for NA1-2000X drawer type)

The transparent protective cover is installed on the door frame of the cabinet door to achieve IP54 protection.

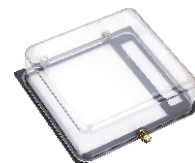

Figure 83.Transparent protective cover



12.15.2 Triple Interlock (can realize interlocking of three horizontal three-pole or four-pole circuit breakers)

The distance of right mounting plates between two adjacent breakers  $\leq 1m$ .

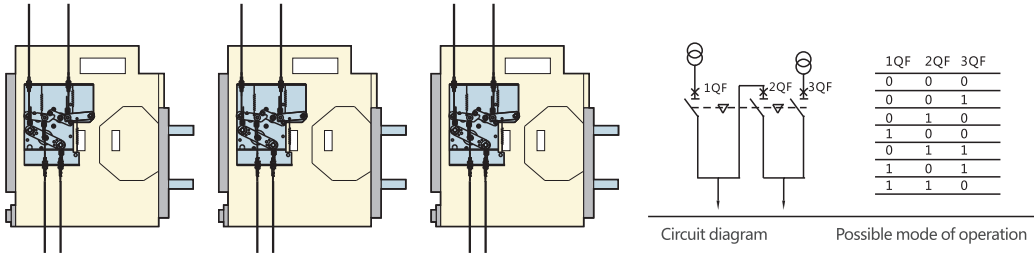

Figure 86. Steel cable triple interlock

12.16 Connecting Rod Interlock (available for NA1-2000X-6300X products, not for NA1-1000X products)

For two vertically mounted three-pole or four-pole circuit breakers, the interlock can be realized where one makes and the other breaks.

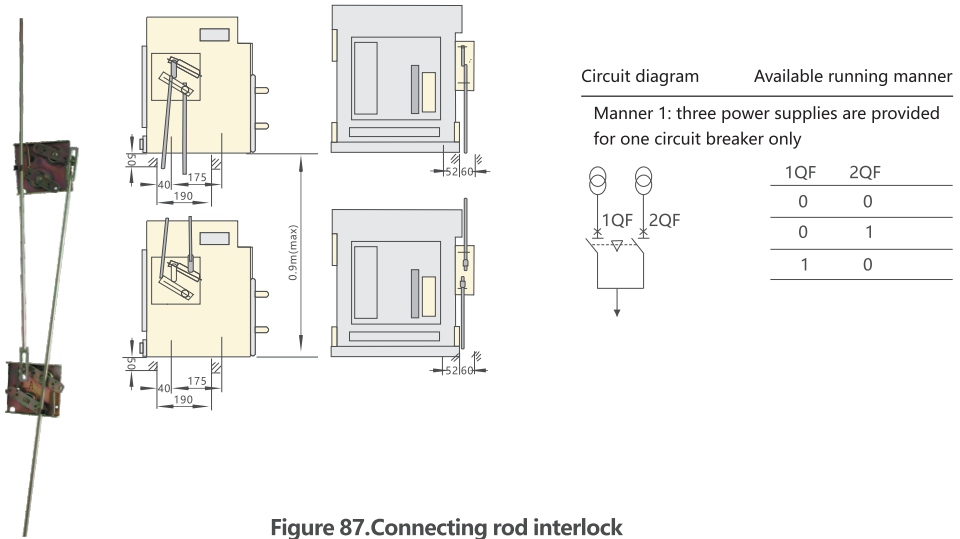

Figure 87. Connecting rod interlock

12.17 External Leakage Transformer (E Mode)

The external leakage transformer is suitable for leakage faults caused by equipment insulation damage or by human body exposure to exposed conductive parts. The leakage release value  $I\Delta n$  is directly expressed in amperes, irrelevant to the rated current of the circuit breaker. The signal is taken in a zero-sequence sampling mode, and a rectangular transformer is required. This sampling has high precision and high sensitivity and is suitable for protection of a small current.

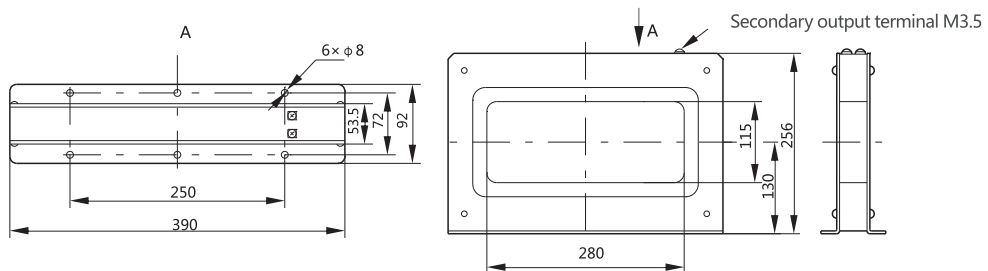

Figure 88. ZCT1: rectangular leakage transformer

Note: ZCT1 provides the busbar pass-through method for NA1-1000X(3P/4P) and NA1-2000X(3P) products, not for NA1-2000X(4P) and NA1-3200X-6300X products.

12.17.1 Leakage Protection Related Setting Parameters

**Table 28 Earthing protection parameter setting**

Parameter name In(A)	Setting range	Setting step
Operating current setting value $I_{\Delta n}$	(0.5-30.0)A	Step size 0.1 A
Delay time $T_{\Delta n}(S)$	Instantaneous, 0.06, 0.08, 0.17, 0.25, 0.33, 0.42, 0.5, 0.58, 0.67, 0.75, 0.83	
Execution mode	trip / close	

12.17.2 Leakage Protection Action Characteristics

**Table 29 Leakage protection action characteristics**

Characteristics	Current multiple ( $I/I_{\Delta n}$ )	Appointed trip time	Delay tolerance
Non-action characteristics	< 0.8	Non-action	
Action characteristics	> 1.0	Action	
Action characteristics	$\geq 1.0$	See Table 30	$\pm 10\%$ (inherent absolute error $\pm 40ms$ )

**Table 30 Leakage protection action delay**

Maximum disconnection time(s) / setting time(s) / Fault current	setting time(s)												
	0.06	0.08	0.17	0.25	0.33	0.42	0.5	0.58	0.67	0.75	0.83	Instantaneous	
$I_{\Delta n}$	0.36	0.5	1	1.5	2	2.5	3	3.5	4	4.5	5	0.04	
$2I_{\Delta n}$	0.18	0.25	0.5	0.75	1	1.25	1.5	1.75	2	2.25	2.5	0.04	
$5I_{\Delta n}$	0.072	0.1	0.2	0.3	0.4	0.5	0.6	0.7	0.8	0.9	1	0.04	
$10I_{\Delta n}$													

12.17.3 Leakage protection detection principle shown in Figure 87.

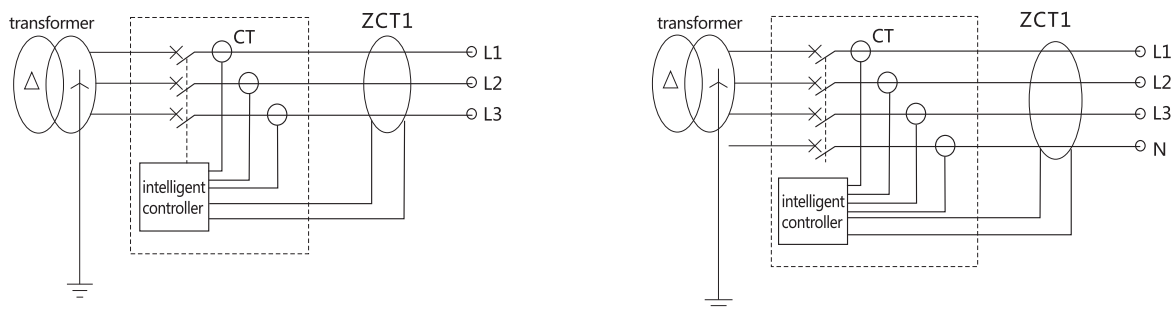

**Figure 87. Leakage protection detection principle**

12.18 External Ground Current Transformer (W Mode)

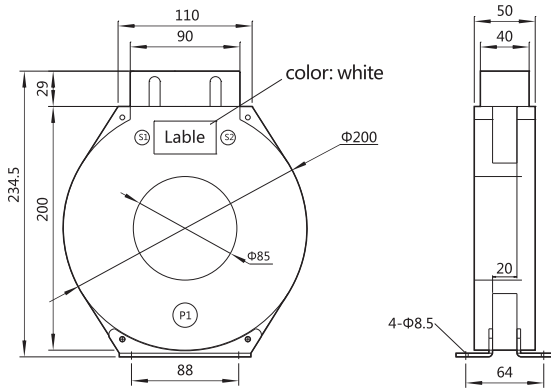
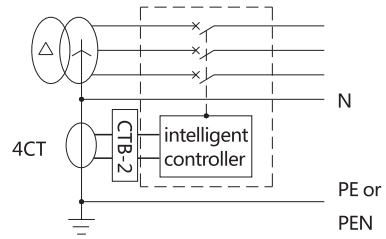

Figure 90. External ground current transformer size



4CT: Additional special transformer,  
CTB-2: ground current transformer module

Figure 91. Ground current protection principle

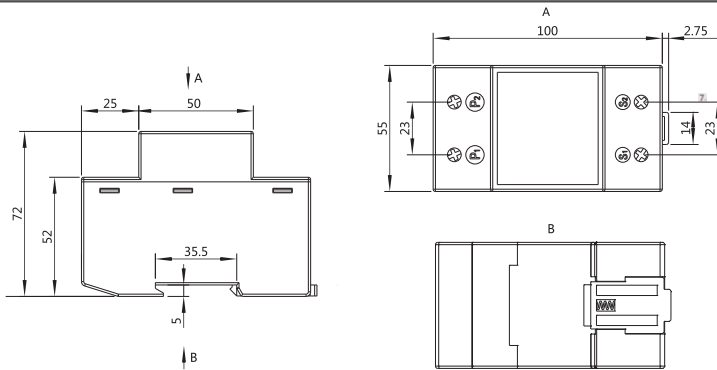

Figure 92. CTB-2 Earthing current transformer module

12.19 Differential Earthing Protection Principle

Metal earthing protection with single-phase earthing protection fault current of several hundred amperes is generally used for neutral point direct ground system. The controller has two different protection modes: one is the vector sum mode without external transformers, and the other is the vector sum mode with external transformers. As shown in Figure 91:

a) In the three-phase three-wire system, the three-pole circuit breaker is selected without a transformer, the ground fault signal only takes the vector sum of the three-phase current, and the protection characteristic is the time-limited protection. (See Figure 91-a 3PT mode)

b) In the three-phase four-wire system, the four-pole circuit breaker is selected without a transformer, the ground fault signal only takes the vector sum of the three-phase current and the N pole current, and the protection characteristic is the time-limited protection. (See Figure 91-b 4PT mode)

c) In the three-phase four-wire system, the three-pole circuit breaker is selected with an external neutral pole N current transformer for grounding protection (the 1000 model is connected to 6# and 7# terminal blocks and 2000-6300 models connected to 25# and 26# terminal blocks), the ground fault signal takes the vector sum of the three-phase current and the N pole current, and the protection characteristic is the time-limited protection. (See Figure 91-c (3P+N)T mode)

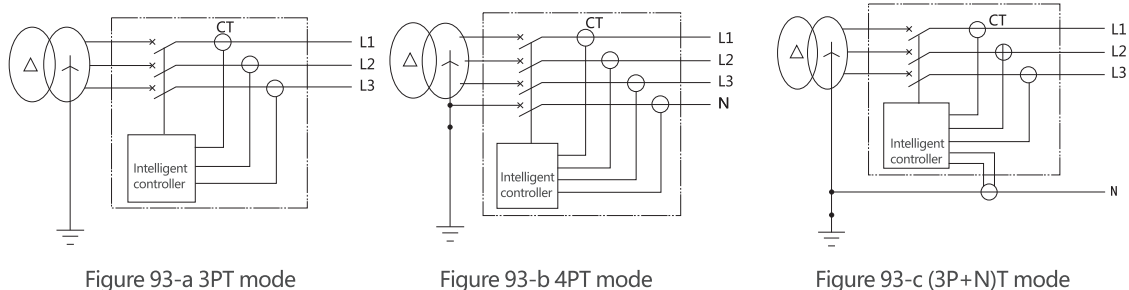
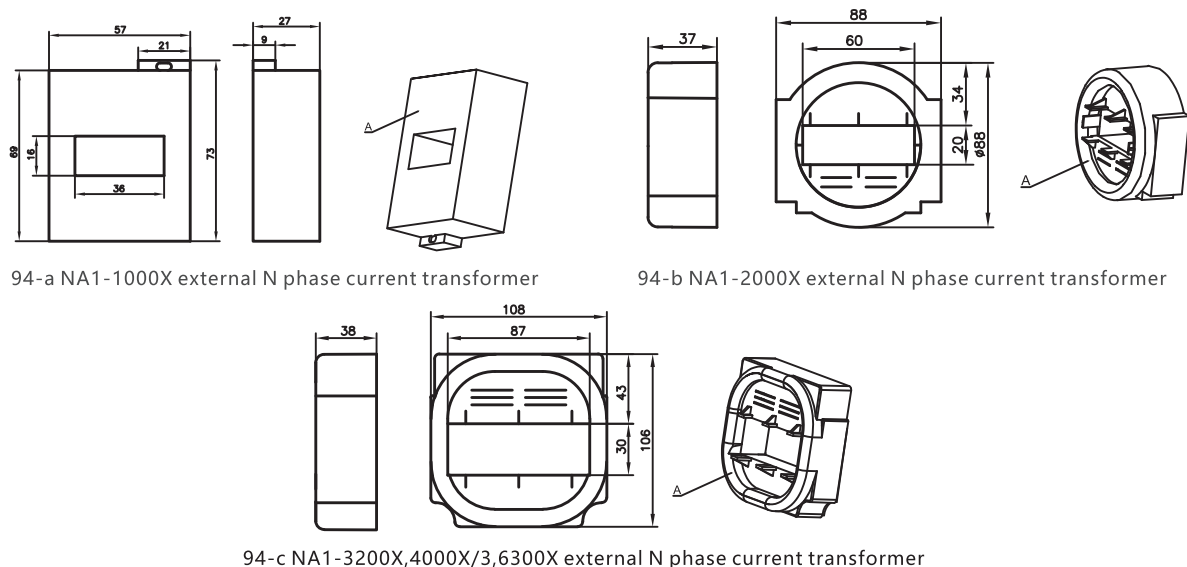

**Figure 93.earthing protection modes**

**Note:** (1) The external N-phase current transformer is a specially configured transformer of the company. The lead length is 2 m by default;  
 (2) In the 3PT mode, the earthing protection can only be used for balanced loads. For unbalanced loads, this function should be turned off or the set value should be set above the allowable current; otherwise, the intelligent controller may be activated;  
 (3) In the (3P+N)T mode, the maximum distance between the transformer and the circuit breaker should not exceed 5 m. When the lead length of the transformer exceeds 2 m, it must be specified when ordering.

### 12.20 External N-phase transformer (3P+N mode) structure dimensions

When the controller is 3P+N, the external additional neutral pole transformer's installation dimensions are shown in Figure 94.



**Note:** If the ACB is up lead connection, side A should face the load side. If the ACB is down lead connection, side A should face the power supply side.

**Figure 94.External Ground Current Transformer**

### 12.21 NA1 Mechanical Interlock Installation Method

The following precautions should be considered before installing the mechanical interlock:

1. When the steel cable needs to be bent, there should be enough transition arc (greater than R120 mm) at the bend to ensure flexible movement of the steel cable;
2. Check the steel cable and ensure that there is enough oil in the cable to ensure flexible movement of the cable;
3. Add low temperature grease to the steel cable at both ends and the roller;
4. The length of the steel cable is 2 m by default. The recommended installation distance is no more than 1.6 meters.

#### 12.21.1 NA1 Drawer Circuit Breaker Mechanical Interlock Installation Method

a. Mechanical interlock components



Interlock mechanism

+



Lever

+



M4x8mm screw (user self-provided)

**Figure 95.NA1-1000X mechanical interlock components**



Interlock mechanism

+



Lever

+



M5x10mm and M5x8mm screw (user self-provided)

**Figure 96.NA1-2000X-6300X mechanical interlock components**

b. Installation steps

Install the lever on the right spindle of the body and secure it with the M4x10mm screw.

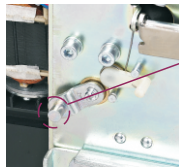

Fix the mechanical interlock on the right side of the drawer seat with 4 M4x8mm screws. The steel cable arc should be reasonable to ensure a reliable interlock mechanism.

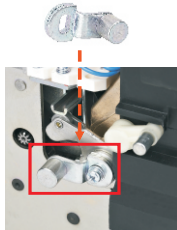

**Figure 97.NA1-1000X mechanical interlock installation**

Remove the cover and pry off the edge here.



Install the lever on the right spindle of the body and secure it with the M5x10mm screw.



The steel cable should be facing down when installing the interlock mechanism. Fix the interlock mechanism on the right side of the drawer seat with 4 M5x8 mm screws. The steel cable arc should be reasonable to ensure a reliable interlock mechanism.

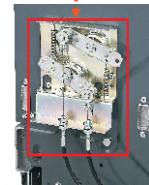

**Figure 98.NA1-2000X-6300X mechanical interlock installation**

12.21.2 NA1 Fixed Circuit Breaker Mechanical Interlock Installation Method

a. Mechanical interlock components

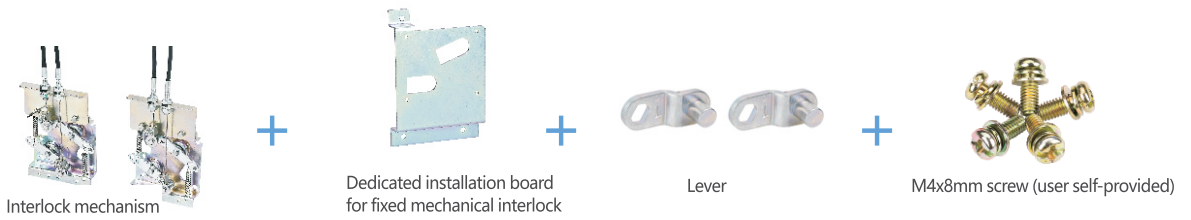

**Figure 99.NA1-1000X mechanical interlock components**

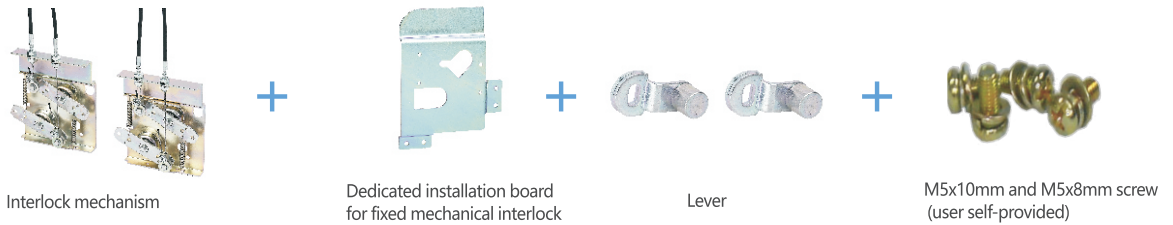

**Figure 100.NA1-2000X-6300X mechanical interlock components**

**Note:** The fixed special interlocking mechanism installation board needs to be purchased separately, and the cost is extra.

**b. Installation steps**

Install the lever on the right spindle of the body and secure it with the M4x10mm screw.

Fix the fixed mechanical interlock installation board on the right side of the circuit breaker and secure it with 3 M4x8mm screws.

Fix the mechanical interlock on the right side of the drawer seat with 4 M4x8 mm screws. The steel cable arc should be reasonable to ensure a reliable interlock mechanism.

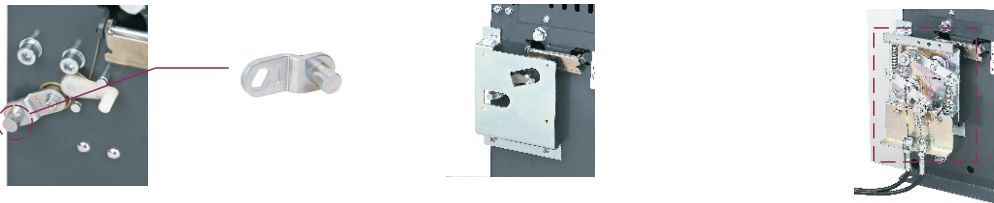

**Figure 101.NA1-1000X mechanical interlock installation**

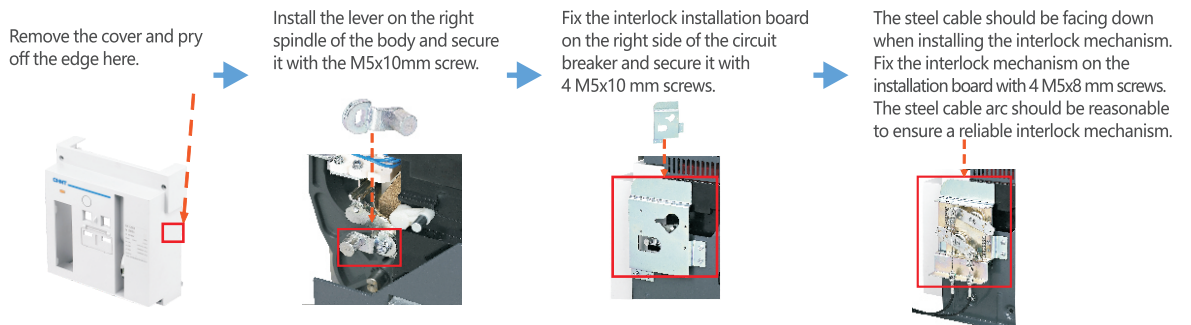

**Figure 102.NA1-2000X-6300X mechanical interlock installation**



**12.22 Installation Dimensions of Undervoltage Delay Controller**

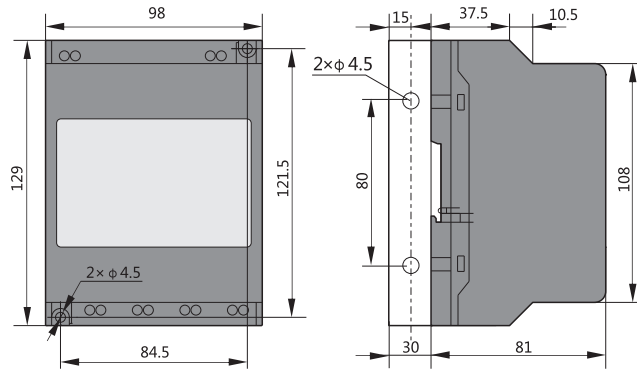

**Figure 103. Undervoltage Delay Controller**

**12.23 PSU-1 Power Module**

The PSU-1 power module can provide DC 24 V power with a power of 9.6 W. It can output two sets of terminals and input AC (AC220V, AC400V) or DC (DC110V, AC220V) power. It can be used as the power supply for the RU-1 relay module. The product adopts the 35 mm standard rail mounting method. The shape and installation dimensions are shown in Figure 104.

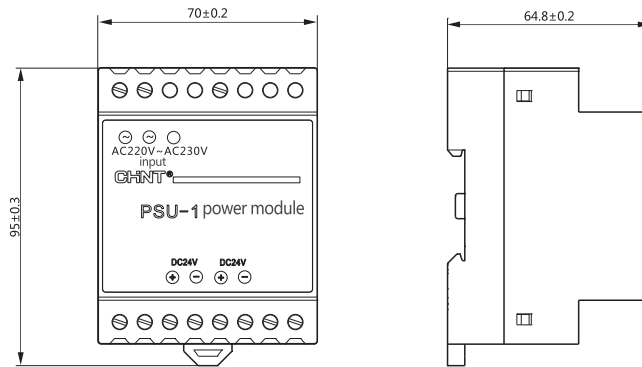

**Figure 104. PSU-1 power module installation structure**

**12.24 RU-1 Power Module**

The signal unit output by the controller is generally used for fault alarm or indication. When it is used to control the breaking and making of the circuit breaker or the load capacity is large, it needs to be controlled after converted by the RU-1 relay module. The capacity of the RU-1 contact is AC250V, 10A; DC28V, 10A. Its shape and installation dimensions are the same as the PSU-1 power module.

**12.25 Mechanical interlock baseplate bore hole dimensions**

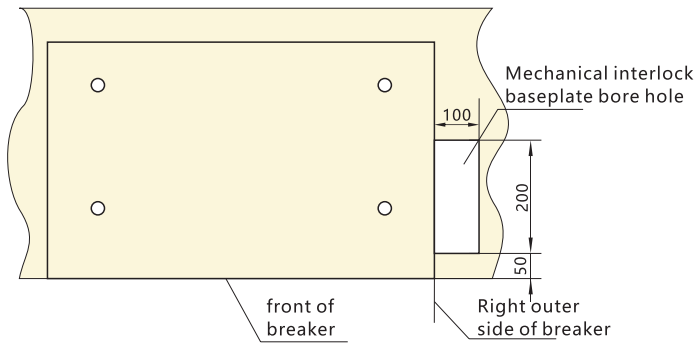

Figure 105.Mechanical interlock baseplate bore hole dimensions

**CHNT**

CHINT ELECTRICS

NA1 Series  
Air Circuit Breaker  
User Instruction

**Zhejiang Chint Electrics Co., Ltd.**

Add: No.1, CHINT Road, CHINT Industrial Zone, North Baixiang,  
Yueqing, Zhejiang 325603, P.R.China

E-mail: [global-sales@chint.com](mailto:global-sales@chint.com)

Website: <http://en.chint.com>

