

In order to protect the environment, when the product or its components are scrapped, please dispose of it as industrial waste; or hand it over to the recycling station for disaggregation, recycling and reuse according to relevant national regulations

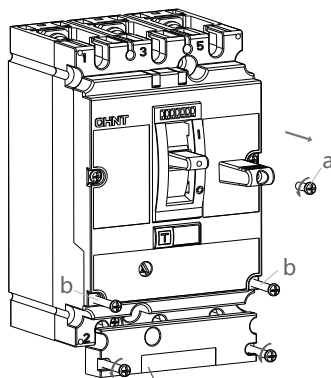

1



- a
ST2.9X13
- b
ST2.9X10

circuit breaker with residual current protection : Remove cover plate

2

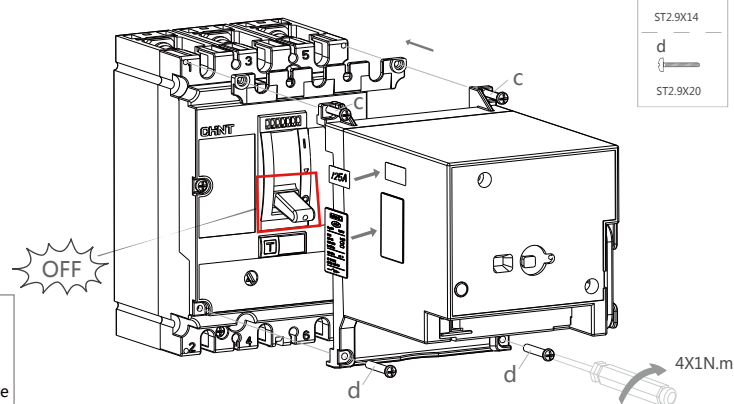

- c
ST2.9X14
- d
ST2.9X20

The nameplate has been given together with NM8N, you have to paste it by yourself

Installation Dimension (mm)

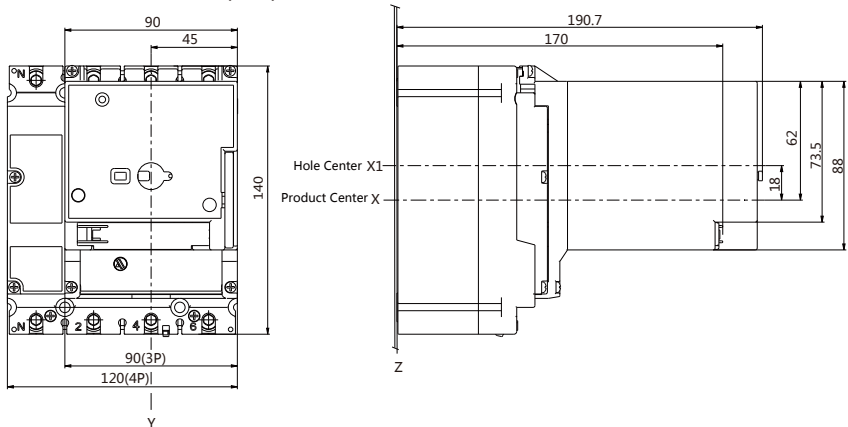

B Operation Mode

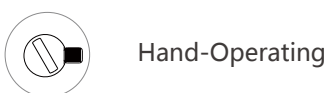
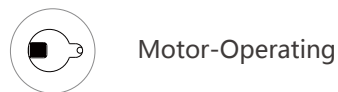
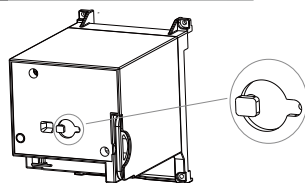

C Motor-Operating

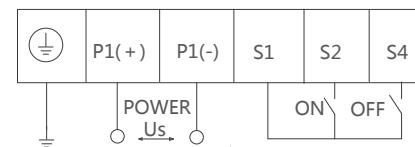
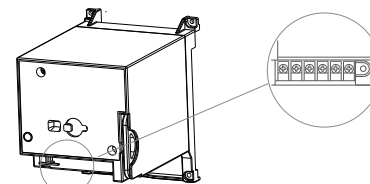

D Hand-Operating

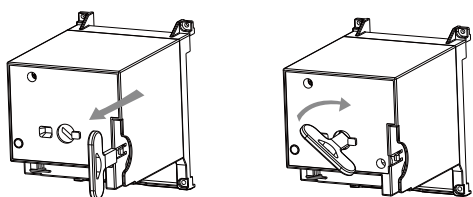
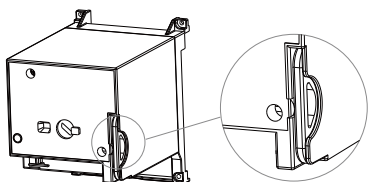

E Operating Instruction

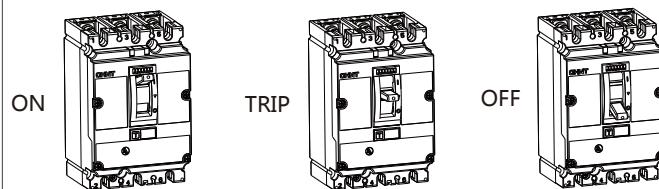

ON-Position:Red TRIP-Position:White OFF-Position:Green

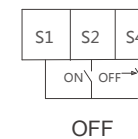
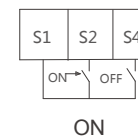
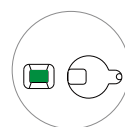
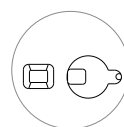
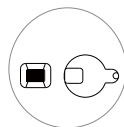

Zhejiang CHINT Electrics Co., Ltd.

Add: No.1, CHINT Road, CHINT Industrial Zone, North Baixiang, Yueqing, Zhejiang Province.

Tel: 86-577-6277777 4001177797

Fax: global-sales@chint.com

Web : http://en.chint.com



